

invenSYS
Eurotherm

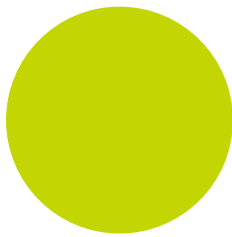

3216, 3208, 3204

User
Manual



3200 Range Process Controller

HA028651/13
Jan 2014

© Copyright Eurotherm Limited 2014

Invensys, Eurotherm, the Eurotherm logo, Chessell, EurothermSuite, Mini8, Eycon, Eyris, EPower, EPack nanodac, piccolo, versadac, optivis, Foxboro, and Wonderware are trademarks of Invensys plc, its subsidiaries and affiliates. All other brands may be trademarks of their respective owners. All rights are strictly reserved. No part of this document may be reproduced, modified or transmitted in any form by any means, neither may it be stored in a retrieval system other than for the purpose to act as an aid in operating the equipment to which the document relates, without the prior written permission of Invensys Eurotherm Limited.



Eurotherm Limited pursues a policy of continuous development and product improvement. The specifications in this document may therefore be changed without notice. The information in this document is given in good faith, but is intended for guidance only. Eurotherm Limited will accept no responsibility for any losses arising from errors in this document.

3200 Series PID Temperature Controllers

User Manual Part Number HA028651 Issue 13.0 Jan-14

Includes 3216, 3208, 32h8 and 3204 Controllers.

Contents

1.	Installation and Basic Operation	6
1.1	What Instrument Do I Have?	6
1.2	Unpacking Your Controller.....	6
1.3	Dimensions	6
1.4	Step 1: Installation	7
1.4.1	Panel Mounting the Controller.....	7
1.4.2	Panel Cut Out Sizes.....	7
1.4.3	Recommended minimum spacing of controllers.....	7
1.4.4	To Remove the Controller from its Sleeve	7
1.5	Order Code	8
2.	Step 2: Wiring	9
2.1	Terminal Layout 3216 Controller	9
2.2	Terminal Layout 32h8 Controllers.....	10
2.3	Terminal Layout 3208 and 3204 Controllers	11
2.4	Wire Sizes	12
2.5	Precautions	12
2.6	Sensor Input (Measuring Input).....	12
2.6.1	Thermocouple Input.....	12
2.6.2	RTD Input.....	12
2.6.3	Linear Input (mA or mV).....	12
2.6.4	Two-Wire Transmitter Inputs	12
2.7	Input/Output 1 & Output 2.....	13
2.7.1	Relay Output (Form A, normally open)	13
2.7.2	Logic (SSR drive) Output	13
2.7.3	DC Output	13
2.7.4	Triac Output.....	13
2.7.5	Logic Contact Closure Input (I/O 1 only)	13
2.8	Remote Setpoint Input.....	13
2.9	Output 3	13
2.10	Summary of DC Outputs	13
2.11	Output 4 (AA Relay).....	14
2.12	General Note About Relays and Inductive Loads	14
2.13	Digital Inputs A & B.....	14
2.14	Current Transformer	14
2.15	Transmitter Power Supply	14
2.16	Digital Communications	15
2.17	Controller Power Supply	16
2.18	Example Heat/Cool Wiring Diagram	16
2.18.1	Example CT Wiring Diagram.....	16
3.	Safety and EMC Information	17
3.1	Installation Safety Requirements.....	17
4.	Switch On.....	19
4.1	New Controller	19
4.1.1	Quick Start Code	19
4.2	To Re-Enter Quick Code mode.....	20
4.3	Pre-Configured Controller or Subsequent Starts.....	20
4.4	Front Panel Layout.....	21
4.4.1	To Set The Target Temperature.....	21
4.4.2	Alarms.....	21
4.4.3	Alarm Indication	21
4.4.4	Auto, Manual and Off Mode.....	22
4.4.5	To Select Auto, Manual or Off Mode.....	22
4.4.6	Level 1 Operator Parameters	23

5.	Operator Level 2	23
5.1	To Enter Level 2.....	23
5.2	To Return to Level 1.....	23
5.3	Level 2 Parameters.....	23
5.4	Timer Operation.....	27
5.5	Dwell Timer.....	28
5.6	Delayed Timer.....	28
5.7	Soft Start Timer.....	29
5.8	Programmer.....	29
5.8.1	Programmer Servo Mode and Power Cycling.....	30
5.8.2	To Operate the Programmer.....	30
5.8.3	To Configure the Programmer.....	31
6.	Access to Further Parameters	32
6.1	Parameter Levels.....	32
6.1.1	Level 3.....	32
6.1.2	Configuration Level.....	32
6.1.3	To Select Access Level 3 or Configuration Level.....	33
6.2	Parameter lists.....	34
6.2.1	To Choose Parameter List Headers.....	34
6.2.2	To Locate a Parameter.....	34
6.2.3	How Parameters are Displayed.....	34
6.2.4	To Change a Parameter Value.....	34
6.2.5	To Return to the HOME Display.....	34
6.2.6	Time Out.....	34
6.3	Navigation Diagram.....	35
6.4	Access Parameters.....	36
7.	Controller Block Diagram	38
8.	Temperature (or Process) Input	39
8.1	Process Input Parameters.....	39
8.1.1	Input Types and Ranges.....	40
8.1.2	Operation of Sensor Break.....	41
8.2	PV Offset.....	42
8.2.1	Example: To Apply an Offset:-.....	42
8.3	PV Input Scaling.....	42
8.3.1	Example: To Scale a Linear Input.....	42
9.	Input/Output	43
9.1	Input/Output Parameters.....	44
9.1.1	Input/Output 1 List (IO-1).....	44
9.1.2	Remote Digital Setpoint Select and Remote Fail.....	46
9.1.3	Sense.....	46
9.1.4	Source.....	46
9.1.5	Power Fail.....	46
9.1.6	Example: To Configure IO-1 Relay to Operate on Alarms 1 and 2:-.....	46
9.1.7	Output List 2 (OP-2).....	47
9.1.8	Output List 3 (OP-3).....	48
9.1.9	AA Relay (AA) (Output 4).....	49
9.1.10	Digital Input Parameters.....	50
9.2	Current Transformer Input Parameters.....	51
9.2.1	Analogue Representation of Current Alarms.....	51
10.	Setpoint Generator	52
10.1	Setpoint Parameters.....	52
10.2	Example: To Set Ramp Rate.....	53
11.	Control	54
11.1	Types of Control.....	54
11.1.1	On/Off Control.....	54
11.1.2	PID Control.....	54
11.1.3	Motorised Valve Control.....	55
11.1.3.1	Motorised Valve Control in Manual mode.....	55
11.2	Control Parameters.....	56
11.2.1	Proportional Band 'PB'.....	58
11.2.2	Integral Term 'TI'.....	58
11.2.3	Derivative Term 'TD'.....	59
11.2.4	Relative Cool Gain 'R2G'.....	59

11.2.5	High and Low Cutback.....	60
11.2.6	Manual Reset.....	60
11.2.7	Control Action.....	60
11.2.8	Loop Break.....	60
11.2.9	Cooling Algorithm.....	60
11.3	Tuning.....	61
11.3.1	Loop Response.....	61
11.3.2	Initial Settings.....	61
11.3.3	Automatic Tuning.....	63
11.3.4	To Start Autotune.....	63
11.3.5	Autotune from Below SP – Heat/Cool.....	64
11.3.6	Autotune From Below SP – Heat Only.....	65
11.3.7	Autotune at Setpoint – Heat/Cool.....	66
11.3.8	Manual Tuning.....	67
11.3.9	Manually Setting Relative Cool Gain.....	67
11.3.10	Manually Setting the Cutback Values.....	68
11.4	Auto-tune Configures R2G.....	69
11.5	Example: To Configure Heating and Cooling.....	70
11.5.1	Effect of Control Action, Hysteresis and Deadband.....	71
12.	Alarms.....	72
12.1	Types of Alarm.....	72
12.1.1	Alarm Relay Output.....	74
12.1.2	Alarm Indication.....	74
12.1.3	To Acknowledge An Alarm.....	74
12.2	Behaviour of Alarms After a Power Cycle.....	75
12.2.1	Example 1.....	75
12.2.2	Example 2.....	75
12.2.3	Example 3.....	75
12.3	Alarm Parameters.....	76
12.3.1	Example: To Configure Alarm 1.....	77
12.4	Diagnostic Alarms.....	78
12.4.1	Out of Range Indication.....	78
13.	Timer/Programmer.....	79
13.1	Timer Parameters.....	79
13.2	Programmer.....	81
13.2.1	Threshold.....	81
13.2.2	Run/End Digital Outputs.....	82
13.2.3	Event Output During a Segment.....	82
13.2.4	To Configure the Programmer.....	83
13.3	Example: To Configure a Dwell Timer as a Simple Two Step Programmer.....	84
14.	Recipe.....	87
14.1	To Save Values in a Recipe.....	87
14.2	To Save Values in a Second Recipe.....	87
14.3	To Select a Recipe to Run.....	88
14.3.1	List of Default Recipe Parameters:.....	88
15.	Digital Communications.....	89
15.1	Digital Communications Wiring.....	89
15.1.1	EIA232.....	89
15.1.2	EIA485 (2-wire).....	89
15.1.3	Wiring EIA422 or 4-wire EIA485.....	89
15.2	Digital Communications Parameters.....	90
15.2.1	Broadcast Communications.....	91
15.2.2	Broadcast Master Communications.....	91
15.2.3	Wiring Connections.....	91
15.3	EEPROM Write Cycles.....	92
15.4	Example: To Set Up Instrument Address.....	93
15.5	DATA ENCODING.....	93
15.6	Parameter Modbus Addresses.....	94
16.	Calibration.....	104
16.1	To Check Input Calibration.....	104
16.1.1	Precautions.....	104
16.1.2	To Check mV Input Calibration.....	104
16.1.3	To Check Thermocouple Input Calibration.....	104

16.1.4	To Check RTD Input Calibration.....	105
16.2	Offsets	105
16.2.1	Two Point Offset.....	105
16.2.2	To Apply a Two Point Offset.....	106
16.2.3	To Remove the Two Point Offset.....	106
16.3	Input Calibration.....	107
16.3.1	To Calibrate mV Input.....	107
16.3.2	To Calibrate Thermocouple Input.....	108
16.3.3	To Calibrate RTD Input.....	109
16.3.4	To Calibrate mA Outputs.....	110
16.3.5	To Calibrate Remote Setpoint Input.....	111
16.3.6	CT Calibration.....	112
16.3.7	To Return to Factory Calibration.....	112
16.4	Calibration Parameters	113
17.	Configuration Using iTools	114
17.1	Loading an IDM.....	114
17.2	Connecting a PC to the Controller	114
17.2.1	Using the H Communications Port.....	114
17.2.2	Configuration Clip.....	114
17.3	Starting iTools.....	115
17.4	Starting the Wizard.....	116
17.5	To configure the Input.....	117
17.5.1	Example 1 - Using the Wizard.....	117
17.5.2	Example 2 – Using the Browser View	117
17.6	To Configure Alarms	118
17.6.1	Example 1: Using the Wizard.....	118
17.6.2	Example 2: Using the Browser View.....	118
17.7	To Customise Messages.....	119
17.7.1	Example 1: Using the Wizard.....	119
17.7.2	Example 2: Using the Browser View.....	120
17.7.3	Example 3: Inverted Status Word	121
17.7.4	Example 4: Display the message 'OUT OF CONTROL' if both Alarm 1 and Alarm 2 are active.....	122
17.8	To Promote Parameters.....	123
17.8.1	Example 1: Using the Wizard.....	123
17.8.2	Example 2: Using the Browser view	124
17.9	To Load A Special Linearisation Table	125
17.9.1	Example: Using the Browser view.....	125
17.10	To Set up Recipes	126
17.10.1	Example 1: Using the Browser view	126
17.10.2	Example 2: Using the Wizard.....	127
17.10.2.1	Recipe Definition.....	127
17.10.2.2	Editing Recipe Values.....	128
17.10.2.3	Recipe Names.....	128
17.11	Summary.....	129
17.11.1	Example 1: Using the Wizard.....	129
17.11.2	Example 2: Using the browser view.....	129
17.12	Cloning.....	130
17.12.1	Save to File.....	130
17.12.2	To Clone a New Controller.....	130
18.	Appendix A TECHNICAL SPECIFICATION	131
19.	Parameter Index	133
20.	Index.....	135

Issue Status of this Manual

Issue 5 of this Handbook applies to software versions 2.09 and above for PID controller and 2.29 and above for Valve Position controllers and includes:-

- Remote Setpoint Input Option RCL
- Programmer Cycles
- Triac output
- EIA422 4-wire Digital Communications, Option 6XX available in 3216 only

It also applies to firmware versions 2.11 and includes new parameters:-

Inverted status word, section 17.7.3.

Rate of change alarms, section 12.3.

Setpoint retransmission limits, section 10.1.

Input filter, section 8.1.

Note:-

The 3116 controller is no longer available. Details may be found in issue 4 of this manual.

Issue 6 includes parameter 'AT.R2G', section 11.4.

Issue 7 corrects range limits in section 8.1.1. Change to definition of LOC.T. in section 10.1. Correct description of enumerations for parameter IM section 15.6.

Issue 8 includes the following changes:

The description of the Programmer in sections 5.8 and 13.2.

A more detailed description of loop tuning.

Updates to Appendix A, Technical Specification.

Issue 9 includes the following changes:

Clarification of order codes for isolated and non- isolated outputs in appropriate sections

Add Tune Hi and Tune Lo limit parameters to the Control table in section 11.2.

Issue 10 applies to software versions 2.13 for PID controllers and 2.32 for Valve Position controllers and includes the following changes:

Warning added to section 15.1.3. ref number of writes to EEPROM.

Notes column in section 13.2.4. - changes to the resolution of Dwell units and Ramp Rate refers to section 10.1.

Sections 2.8 and 4.4.3. clarify remote setpoint operation.

Issue 11 corrects instruction 3) in section 11.4; adds Certificate of Conformity; adds a new section 15.3 EEPROM Write Cycles; update DIN3440 to EN14597TR in the Approvals section 18.

Issue 12 corrects the note (2) in section 2.1 to EIA422 and deletes the corresponding statement in section 2.14. Contact resistance ratings changed in section 2.13.

Issue 13 changes panel sealing ratings in the Specification section. Remove Declaration of Conformity.

1. Installation and Basic Operation

1.1 What Instrument Do I Have?

Thank you for choosing this 3200 series Temperature Controller/Programmer.

The 3200 series provide precise temperature control of industrial processes and is available in three standard DIN sizes:-

- 1/16 DIN Model Number 3216
- 1/8 DIN Model Number 3208
- 1/8 DIN Horizontal Model Number 32h8
- 1/4 DIN Model Number 3204

A universal input accepts various thermocouples, RTDs or process inputs. Up to three (3216) or four (3208, 32h8 and 3204) outputs can be configured for control, alarm or re-transmission purposes. Digital communications and a current transformer input are available as options.

The controller may have been ordered to a hardware code only or pre-configured using an optional 'Quick Start' code.

The label fitted to the side of the sleeve shows the ordering code that the controller was supplied to.

The last two sets of five digits show the Quick Start Code. If the Quick Start Code shows *****/**** the controller was supplied with default parameters and will need to be configured when it is first switched on.

This Manual takes you through all aspects of installation, wiring, configuration and use of the controller.

1.2 Unpacking Your Controller

The controller is supplied with:-

- Sleeve (with the controller fitted in the sleeve)
- Two panel retaining clips and IP65 sealing gasket mounted on the sleeve
- Component packet containing a snubber for each relay output (see section 2.12) and a 2.49Ω resistor for current inputs (see section 2.6)
- Installation sheet Part Number HA029714

1.3 Dimensions

General views of the controllers are shown below together with overall dimensions.

3216

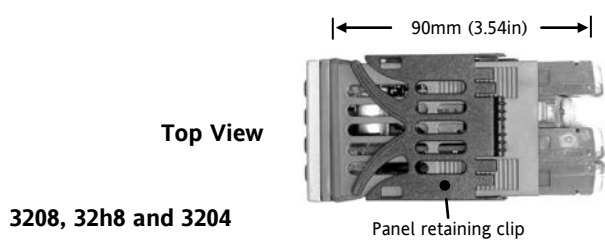
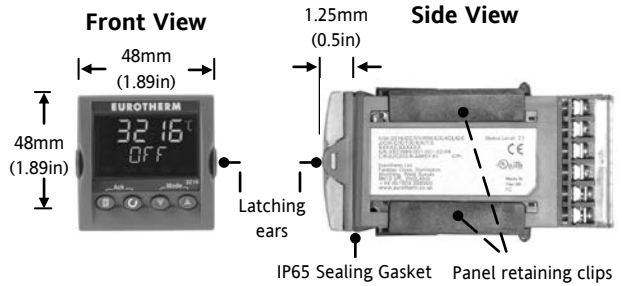

3208, 32h8 and 3204

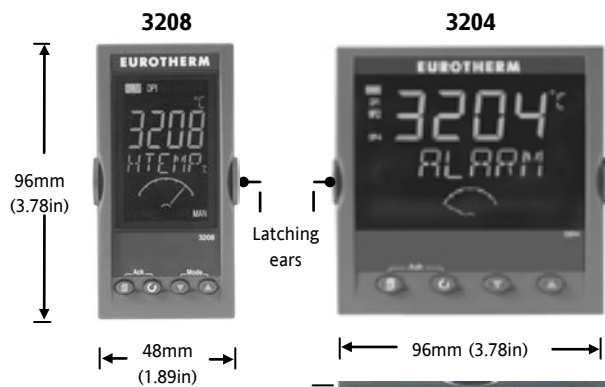

Front Views

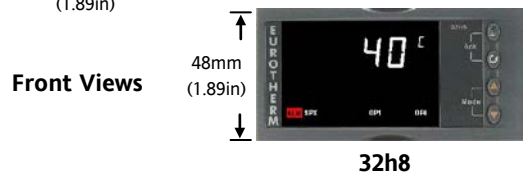

Side View

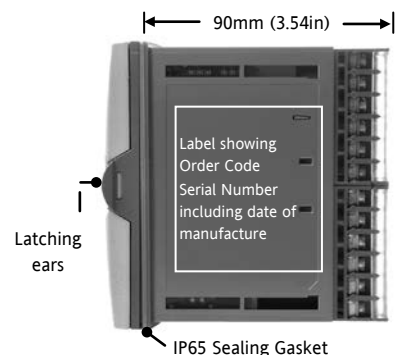

1.4 Step 1: Installation

This instrument is intended for permanent installation, for indoor use only, and enclosed in an electrical panel. Select a location which is subject to minimum vibrations the ambient temperature is within 0 and 55°C (32 - 131°F) and humidity 5 to 95% RH non condensing.

The instrument can be mounted on a panel up to 15mm thick.

To ensure IP65 front protection, mount on a non-textured surface.

Please read the safety information in section 3 before proceeding. The EMC Booklet part number HA025464 gives further installation information.

1.4.1 Panel Mounting the Controller

1. Prepare a cut-out in the mounting panel to the size shown. If a number of controllers are to be mounted in the same panel observe the minimum spacing shown.
2. Fit the IP65 sealing gasket behind the front bezel of the controller
3. Insert the controller through the cut-out
4. Spring the panel retaining clips into place. Secure the controller in position by holding it level and pushing both retaining clips forward.
5. Peel off the protective cover from the display.

1.4.2 Panel Cut Out Sizes

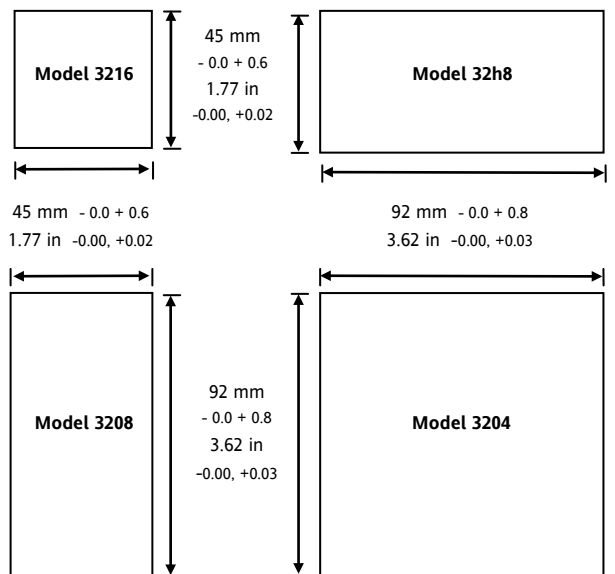

1.4.3 Recommended minimum spacing of controllers

Applies to all models.

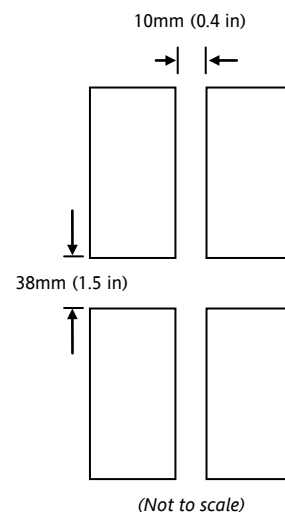

1.4.4 To Remove the Controller from its Sleeve

The controller can be unplugged from its sleeve by easing the latching ears outwards and pulling it forward out of the sleeve. When plugging it back into its sleeve, ensure that the latching ears click back into place to maintain the IP65 sealing

1.5 Order Code

1	2	3	4	5	6	7	8	9	10	11	12	13	14
---	---	---	---	---	---	---	---	---	----	----	----	----	----

1. Model No.	
1/16 DIN size	3216
1/8 DIN size vertical	3208
1/8 DIN horizontal	32h8
1/4 DIN size	3204

2. Function	
Controller	CC
Programmer	CP
valve controller	VC
Valve programmer	VP

3. Power Supply	
24Vac/dc	VL
100–230Vac	VH

4. Output 1 & 2 3216			
OP1	OP2		
L	X	X	X
L	R	X	X
R	R	X	X
L	L	X	X
L	D	X	X
D	D	X	X
D	R	X	X
R	C	X	X
L	C	X	X
D	C	X	X
Not available with low voltage supply option.			
L	T	X	X
T	T	X	X
L = Logic R = Relay T = Triac D = 0-20mA non-isolated C = 0-20mA isolated			

4. Outputs 1, 2 and 3 3208/H8/04			
OP1	OP2	OP3	
L	R	R	X
R	R	R	X
L	L	R	X
L	R	D	X
R	R	D	X
D	D	D	X
L	L	D	X
L	D	D	X
D	R	D	X
Not available with low voltage supply option.			
L	T	R	X
T	T	R	X
L	T	D	X
T	T	D	X
L = Logic R = Relay T = Triac D = 0-20mA non-isolated outputs 1 and 2 D = 0-20mA isolated output 3			

5. AA Relay (OP4)	
Disabled	X
Relay (Form C)	R

6. Options	
Not fitted	XXX
EIA485 & Digital input A	4XL*
EIA232 & Digital input A	2XL*
EIA485, CT & Dig in A	4CL
EIA232, CT & Dig in A	2CL
Digital input A	XXL*
CT & Digital input A	XCL
Remote SP and Logic IP	RCL
4-wire EIA485 (EIA422) Comms (3216 only)	6XX
* 3216 only	

7. Fascia colour/type	
Green	G
Silver	S
Wash down fascia (not 32h8/04)	W

8/9 Product/Manual Language	
English	ENG
French	FRA
German	GER
Italian	ITA
Spanish	SPA

10. Extended Warranty	
Standard	XXXXX
Extended	WL005

11. Certificates	
XXXXX	None
Cert of conformity	CERT1
Factory calibration	CERT2

12. Custom Label	
None	XXXXX

13. Specials Number	
None	XXXXXX
250Ω ; 0-5Vdc OP	RES250
500Ω ; 0-10Vdc OP	RES500

2. Step 2: Wiring

2.1 Terminal Layout 3216 Controller

Ensure that you have the correct supply for your controller
Check order code of the instrument supplied

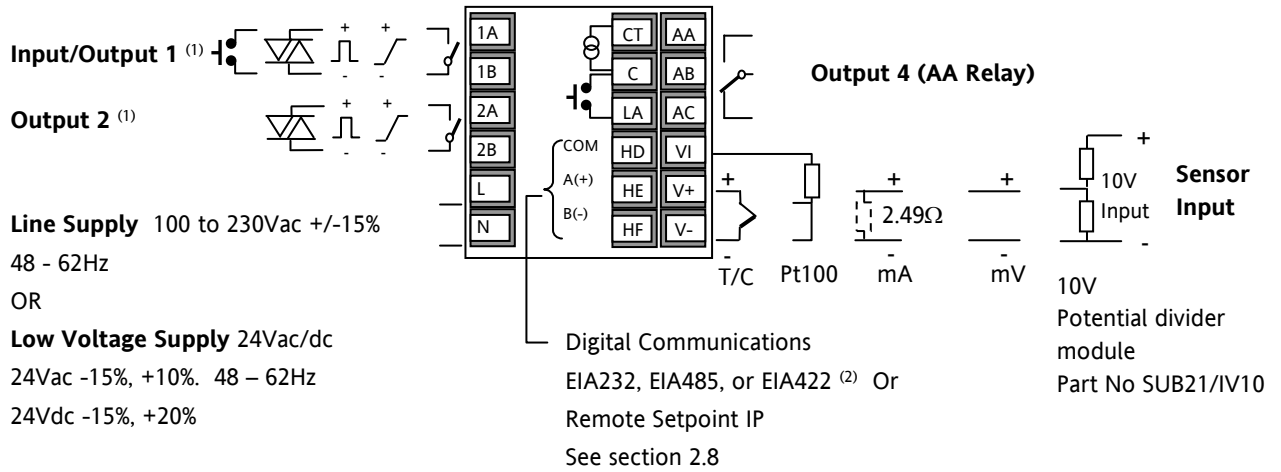

(1) If I/O 1 is fitted with a 0-20mA analogue output then this output is always non-isolated (order code D). Output 2 may be fitted with an isolated 0-20mA output, order code C, or a non-isolated 0-20mA output, order code D.





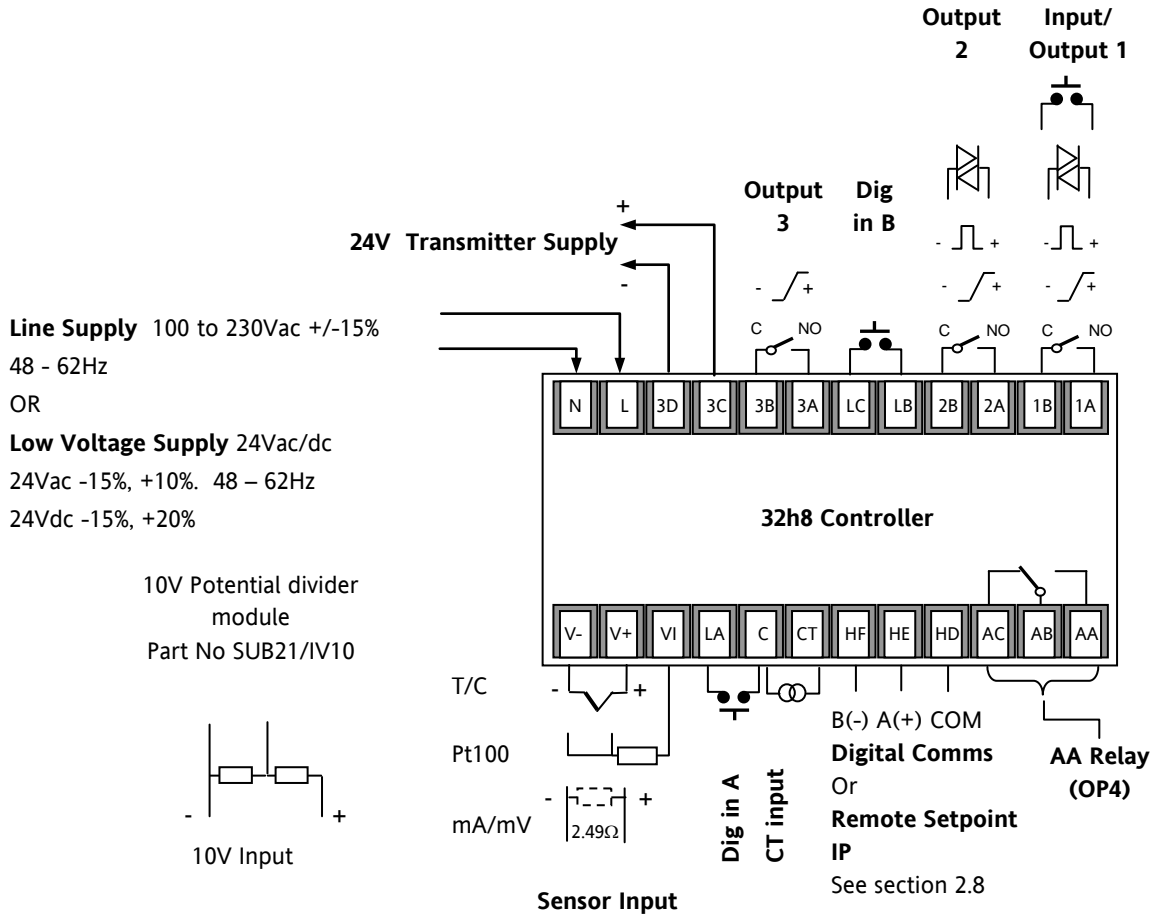

(2) Option 6XX – EIA422 digital communications uses terminals C to HF. This means that the Current Transformer and Digital Input A are not available if this option is fitted.

Key to symbols used in the wiring diagrams					
	Logic (SSR drive) output		Relay output		Contact input
	mA analogue output		Triac output		Current transformer input

2.2 Terminal Layout 32h8 Controllers

 **Ensure that you have the correct supply for your controller**
Check order code of the instrument supplied



Key to symbols used in the wiring diagrams					
	Logic (SSR drive) output		Relay output		Contact input
	mA analogue output		Triac output		Current transformer input

2.3 Terminal Layout 3208 and 3204 Controllers

Ensure that you have the correct supply for your controller
Check order code of the instrument supplied

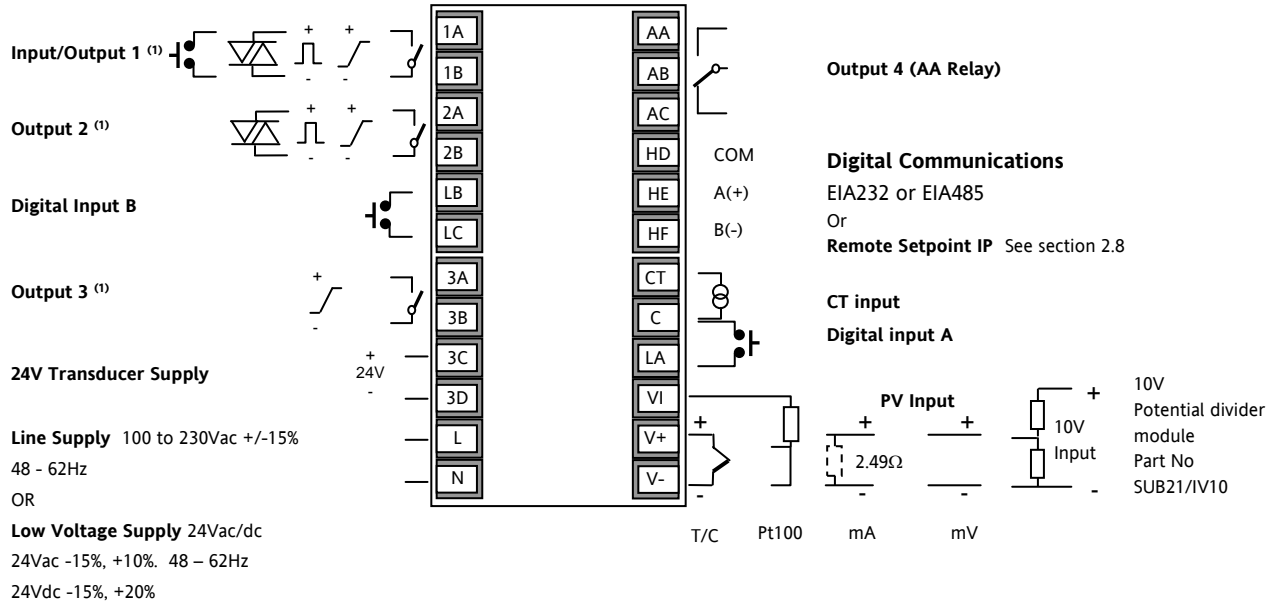

(1) If I/O 1 or OP2 are fitted with a 0-20mA analogue output then these outputs are always non-isolated. If OP 2 is fitted with a 0-20mA analogue output this output is isolated 240Vac. The order code D applies to isolated or non-isolated outputs in 3208, 32h8 and 3204 instruments.

Key to symbols used in the wiring diagrams					
	Logic (SSR drive) output		Relay output		Contact input
	mA analogue output		Triac output		Current transformer input

2.4 Wire Sizes

The screw terminals accept wire sizes from 0.5 to 1.5 mm (16 to 22AWG). Hinged covers prevent hands or metal making accidental contact with live wires. The rear terminal screws should be tightened to 0.4Nm (3.5lb in).

2.5 Precautions

- Do not run input wires together with power cables
- When shielded cable is used, it should be grounded at one point only
- Any external components (such as zener barriers, etc) connected between sensor and input terminals may cause errors in measurement due to excessive and/or un-balanced line resistance or possible leakage currents
- Not isolated from the logic outputs & digital inputs
- Pay attention to line resistance; a high line resistance may cause measurement errors

2.6 Sensor Input (Measuring Input)

2.6.1 Thermocouple Input



- Use the correct compensating cable preferably shielded

2.6.2 RTD Input

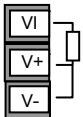

Lead compensation

- The resistance of the three wires must be the same. The line resistance may cause errors if it is greater than 22Ω

2.6.3 Linear Input (mA or mV)

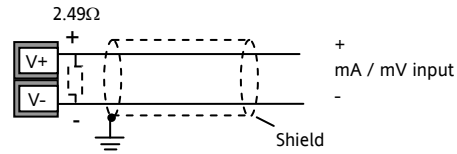

- If shielded cable is used it should be grounded in one place only as shown
- For a mA input connect the 2.49Ω burden resistor supplied between the V+ and V- terminals as shown
- For a 0-10Vdc input an external input adapter is required (not supplied). Part number: SUB21/IV10

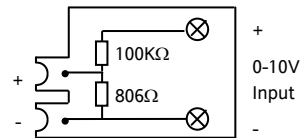

Sensor break alarm does not operate with this adaptor fitted.

2.6.4 Two-Wire Transmitter Inputs

Using internal 24V power supply (3208, 32h8 and 3204 only)

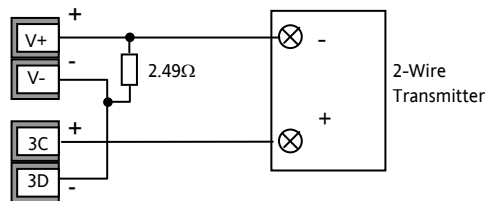

Using external power supply

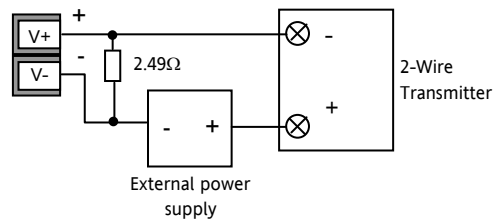

2.7 Input/Output 1 & Output 2

These outputs can be logic (SSR drive), or relay, or mA dc. In addition the logic output 1 can be used as a contact closure input.

For input/output functions, see Quick Start Code in section 4.1.1.

2.7.1 Relay Output (Form A, normally open)

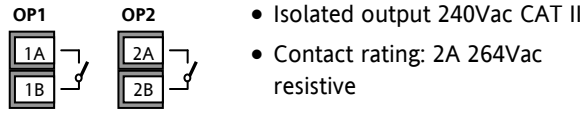

2.7.2 Logic (SSR drive) Output

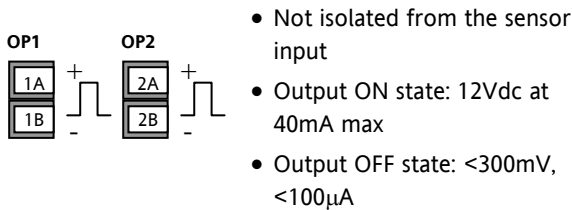

- The output switching rate must be set to prevent damage to the output device in use. See parameter 1.PLS or 2.PLS in section 5.3.

2.7.3 DC Output

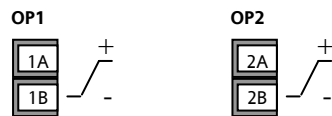

- Order code C (OP2 only) isolated 240Vac
- Order code D not isolated from the sensor input
- Software configurable: 0-20mA or 4-20mA.
- Max load resistance: 500Ω
- Calibration accuracy: \pm (<1% of reading + <100µA)

2.7.4 Triac Output

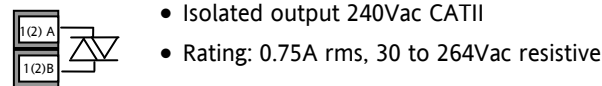

2.7.5 Logic Contact Closure Input (I/O 1 only)

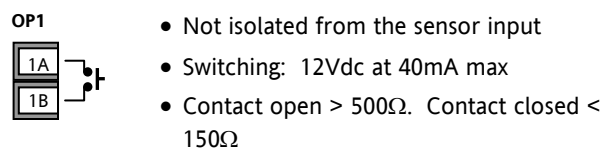

2.8 Remote Setpoint Input

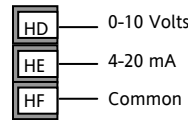

- There are two inputs; 4-20mA and 0-10 Volts which can be fitted in place of digital communications
- It is not necessary to fit an external burden resistor to the 4-20mA input

- If the 4-20mA remote setpoint input is connected and valid (>3.5mA; < 22mA) it will be used as the main setpoint. If it is not valid or not connected the controller will try to use the Volts input. Volts sensor break occurs at <-1; >+11V. The two inputs are not isolated from each other
- If neither remote input is valid the controller will fall back to the internal setpoint, SP1 or SP2 and flash the alarm beacon. The alarm can also be configured to activate a relay (see section 12.1.1) or read over digital communications.
- To calibrate the remote setpoint, if required, see section 16.3.5
- A local SP trim value is available in access level 3 (see section 10.1).

Note: If remote setpoint is configured ensure that the remote input is connected or the relevant rear terminals are linked. If the remote setpoint input is left open circuit the alarm beacon will light.

2.9 Output 3

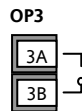

Output 3 is available only in the models 3208, 32h8 and 3204. It will be either a relay or a mA output.

For output functions, see Quick Start Code in section 4.1.1.

Relay Output (Form A, normally open)

Isolated output 240Vac CAT II

- Contact rating: 2A 264Vac resistive

DC Output

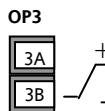

- Isolated output 240Vac CAT II
- Software configurable: 0-20mA or 4-20mA
- Max load resistance: 500Ω
- Calibration accuracy: 0.5%, \pm 100µA

2.10 Summary of DC Outputs

	3216	3208	32h8	3204	Order code
OP1	Non-isolated in all instruments				D
OP2	Non-isolated	Non-isolated	Non-isolated	Non-isolated	D
	Isolated	Isolated	Isolated	Isolated	C
OP3	Not available	Isolated	Isolated	Isolated	D

2.11 Output 4 (AA Relay)

Output 4 is a relay and optionally available in all models. For output functions, see Quick Start Code in section 4.1.1.

Relay Output (Form C)

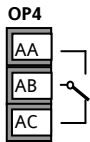

- Isolated output 240Vac CAT II
- Contact rating: 2A 264Vac resistive

2.12 General Note About Relays and Inductive Loads

High voltage transients may occur when switching inductive loads such as some contactors or solenoid valves. Through the internal contacts, these transients may introduce disturbances which could affect the performance of the instrument.

For this type of load it is recommended that a ‘snubber’ is connected across the normally open contact of the relay switching the load. The snubber recommended consists of a series connected resistor/capacitor (typically 15nF/100Ω). A snubber will also prolong the life of the relay contacts.

A snubber should also be connected across the output terminal of a triac output to prevent false triggering under line transient conditions.

WARNING

When the relay contact is open or it is connected to a high impedance load, the snubber passes a current (typically 0.6mA at 110Vac and 1.2mA at 240Vac). You must ensure that this current will not hold on low power electrical loads. If the load is of this type the snubber should not be connected.

2.13 Digital Inputs A & B

Digital input A is an optional input in all 3200 series controllers. Digital input B is always fitted in models 3208, 32h8 and 3204, but is not available in 3216.

Dig in A



Dig in B



- Not isolated from the current transformer input or the sensor input
- Switching: 12Vdc at 40mA max
- Contact open > 600Ω. Contact closed < 300Ω
- Input functions: Please refer to the list in the quick codes.

☺ If EIA232 digital communications is fitted (3216 only), Digital Input A is not available.

2.14 Current Transformer

The current transformer input is an optional input in all 3200 series controllers.

It can be connected to monitor the rms current in an electrical load and to provide load diagnostics. The following fault conditions can be detected: SSR (solid state relay) short circuit, heater open circuit and partial load failure. These faults are displayed as alarm messages on the controller front panel.

CT Input



Note: C terminal is common to both the CT input and Digital input A. They are, therefore, not isolated from each other or the PV input.

- CT input current: 0-50mA rms (sine wave, calibrated) 50/60Hz
- A burden resistor, value 10Ω, is fitted inside the controller.
- It is recommended that the current transformer is fitted with a voltage limiting device to prevent high voltage transients if the controller is unplugged. For example, two back to back zener diodes. The zener voltage should be between 3 and 10V, rated at 50mA.
- CT input resolution: 0.1A for scale up to 10A, 1A for scale 11 to 100A
- CT input accuracy: ±4% of reading.

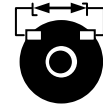

2.15 Transmitter Power Supply

The Transmitter Supply is not available in the Model 3216. It is fitted as standard in the Models 3208, 32h8 and 3204.

Transmitter Supply

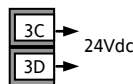

- Isolated output 240Vac CAT II
- Output: 24Vdc, +/- 10%. 28mA max.
- inside the controller

2.16 Digital Communications

Optional.

Digital communications uses the Modbus protocol. The interface may be ordered as EIA232 or EIA485 (2-wire). In 3216 controllers only, EIA422 (4-wire) is available as option 6XX.

- ☺ Digital communications is not available if Remote Setpoint is fitted
- ☺ Cable screen should be grounded at one point only to prevent earth loops.
- Isolated 240Vac CAT II.

EIA232 Connections

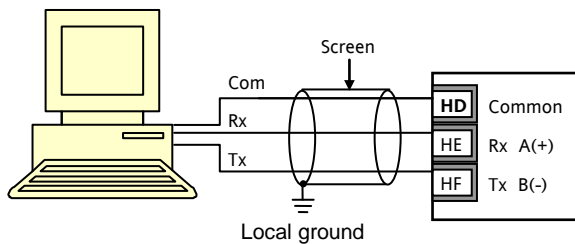

EIA485 Connections

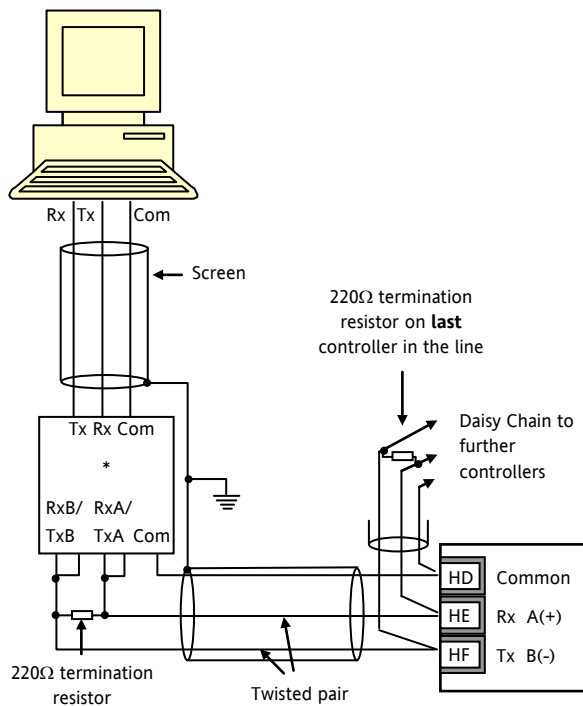

* EIA232/EIA485 2-wire communications converter eg Type KD485

EIA422 Connections (3216 only)

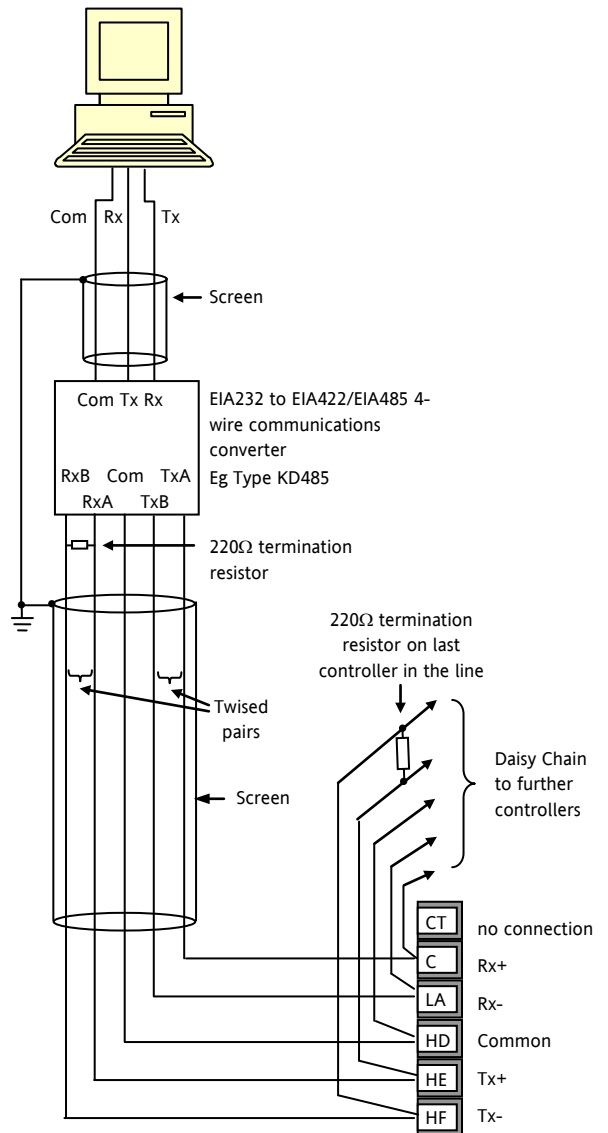

☺ If EIA422 serial communications is fitted, the CT and LA digital input option is not possible since EIA422 shares the same terminals as the CT and LA.

☺ The KD485 communications converter is recommended for:

- Interfacing 4-wire to 2-wire connections.
- To buffer an EIA422/485 network when more than 32 instruments on the same bus are required
- To bridge 2-wire EIA485 to 4-wire EIA422.

2.17 Controller Power Supply

1. Before connecting the instrument to the power line, make sure that the line voltage corresponds to the description on the identification label.
2. Use copper conductors only.
3. For 24V the polarity is not important
4. The power supply input is not fuse protected. This should be provided externally

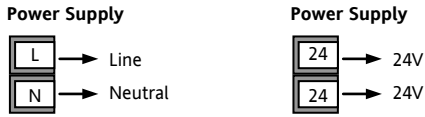

- High voltage supply: 100 to 230Vac, +/-15%, 48 to 62 Hz
- Low voltage supply: 24Vac/dc
24Vac -15%, +10%. 48 – 62Hz
24Vdc -15%, +20%
- Recommended external fuse ratings are as follows:-
For 24 V ac/dc, fuse type: T rated 2A 250V
For 100-240Vac, fuse type: T rated 2A 250V.

2.18 Example Heat/Cool Wiring Diagram

This example shows a heat/cool temperature controller where the heater control uses a SSR and the cooling control uses a relay.

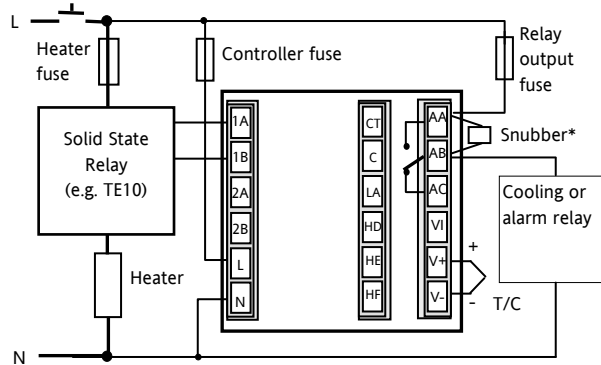

Safety requirements for permanently connected equipment state:

- A switch or circuit breaker shall be included in the building installation
- It shall be in close proximity to the equipment and within easy reach of the operator
- It shall be marked as the disconnecting device for the equipment
- ☺ A single switch or circuit breaker can drive more than one instrument

2.18.1 Example CT Wiring Diagram

This diagram shows an example of wiring for a CT input.

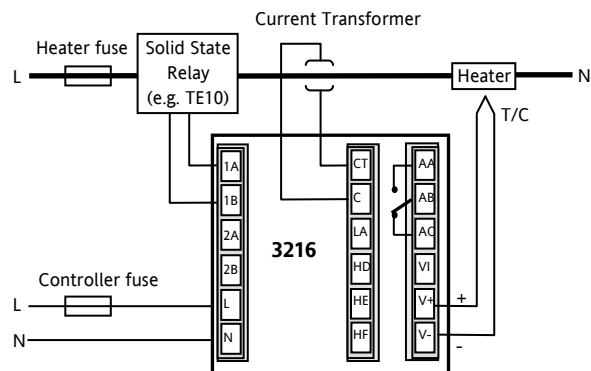

Note: the burden resistor value 10Ω is mounted inside the controller. It is recommended that the current transformer is fitted with a voltage limiting device such as two back to back zener diodes between 3 and 10V and rated for 50mA.

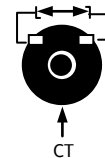

3. Safety and EMC Information

This controller is intended for industrial temperature and process control applications when it will meet the requirements of the European Directives on Safety and EMC. Use in other applications, or failure to observe the installation instructions of this handbook may impair safety or EMC. The installer must ensure the safety and EMC of any particular installation.

Safety

This controller complies with the European Low Voltage Directive 2006/95/EC by the application of the safety standard EN 61010.

Electromagnetic compatibility

This controller conforms with the essential protection requirements of the EMC Directive 2004/108/EC, by the application of a Technical Construction File. This instrument satisfies the general requirements of the industrial environment defined in EN 61326. For more information on product compliance refer to the Technical Construction File.

GENERAL

The information contained in this manual is subject to change without notice. While every effort has been made to ensure the accuracy of the information, your supplier shall not be held liable for errors contained herein.

Unpacking and storage

The packaging should contain an instrument mounted in its sleeve, two mounting brackets for panel installation and an Installation & Operating guide. Certain ranges are supplied with an input adapter.

If on receipt, the packaging or the instrument are damaged, do not install the product but contact your supplier. If the instrument is to be stored before use, protect from humidity and dust in an ambient temperature range of -30°C to +75°C.

SERVICE AND REPAIR

This controller has no user serviceable parts. Contact your supplier for repair.

Caution: Charged capacitors

Before removing an instrument from its sleeve, disconnect the supply and wait at least two minutes to allow capacitors to discharge. It may be convenient to partially withdraw the instrument from the sleeve, then pause before completing the removal. In any case, avoid touching the exposed electronics of an instrument when withdrawing it from the sleeve.

Failure to observe these precautions may cause damage to components of the instrument or some discomfort to the user.

Electrostatic discharge precautions

When the controller is removed from its sleeve, some of the exposed electronic components are vulnerable to damage by electrostatic discharge from someone handling the controller. To avoid this, before handling the unplugged controller discharge yourself to ground.

Cleaning

Do not use water or water based products to clean labels or they will become illegible. Isopropyl alcohol may be used to clean labels. A mild soap solution may be used to clean other exterior surfaces of the product.

3.1 Installation Safety Requirements

Safety Symbols

Various symbols may be used on the controller. They have the following meaning:

 Caution, (refer to accompanying documents)

 Helpful hints

 Equipment protected throughout by DOUBLE INSULATION

Personnel

Installation must only be carried out by suitably qualified personnel in accordance with the instructions in this handbook.

Enclosure of Live Parts

To prevent hands or metal tools touching parts that may be electrically live, the controller must be enclosed in an enclosure.

Caution: Live sensors

The controller is designed to operate if the temperature sensor is connected directly to an electrical heating element. However you must ensure that service personnel do not touch connections to these inputs while they are live. With a live sensor, all cables, connectors and switches for connecting the sensor must be mains rated.

Wiring

It is important to connect the controller in accordance with the wiring data given in this guide. Take particular care not to connect AC supplies to the low voltage sensor input or other low level inputs and outputs. Only use copper conductors for connections (except thermocouple inputs) and ensure that the wiring of installations comply with all local wiring regulations. For example in the UK use the latest version of the IEE wiring regulations, (BS7671). In the USA use NEC Class 1 wiring methods.

Power Isolation

The installation must include a power isolating switch or circuit breaker. This device should be in close proximity to the controller, within easy reach of the operator and marked as the disconnecting device for the instrument.

Overcurrent protection

The power supply to the system should be fused appropriately to protect the cabling to the units.

Voltage rating

The maximum continuous voltage applied between any of the following terminals must not exceed 240Vac:

- relay output to logic, dc or sensor connections;
- any connection to ground.

The controller must not be wired to a three phase supply with an unearthed star connection. Under fault conditions such a supply could rise above 240Vac with respect to ground and the product would not be safe.

Conductive pollution

Electrically conductive pollution must be excluded from the cabinet in which the controller is mounted. For example, carbon dust is a form of electrically conductive pollution. To secure a suitable atmosphere in conditions of conductive pollution, fit an air filter to the air intake of the cabinet. Where condensation is likely, for example at low temperatures, include a thermostatically controlled heater in the cabinet.

This product has been designed to conform to BSEN61010 installation category II, pollution degree 2. These are defined as follows:-

Installation Category II (CAT II)

The rated impulse voltage for equipment on nominal 230V supply is 2500V.

Pollution Degree 2

Normally only non conductive pollution occurs. Occasionally, however, a temporary conductivity caused by condensation shall be expected.

Grounding of the temperature sensor shield

In some installations it is common practice to replace the temperature sensor while the controller is still powered up. Under these conditions, as additional protection against electric shock, we recommend that the shield of the temperature sensor is grounded. Do not rely on grounding through the framework of the machine.

Over-temperature protection

When designing any control system it is essential to consider what will happen if any part of the system should fail. In temperature control applications the primary danger is that the heating will remain constantly on. Apart from spoiling the product, this could damage any process machinery being controlled, or even cause a fire.

Reasons why the heating might remain constantly on include:

- the temperature sensor becoming detached from the process
- thermocouple wiring becoming short circuit;
- the controller failing with its heating output constantly on
- an external valve or contactor sticking in the heating condition
- the controller setpoint set too high.

Where damage or injury is possible, we recommend fitting a separate over-temperature protection unit, with an independent temperature sensor, which will isolate the heating circuit.

Please note that the alarm relays within the controller will not give protection under all failure conditions.

Installation requirements for EMC

To ensure compliance with the European EMC directive certain installation precautions are necessary as follows:

- For general guidance refer to Eurotherm Controls EMC Installation Guide, HA025464.
- When using relay outputs it may be necessary to fit a filter suitable for suppressing the emissions. The filter requirements will depend on the type of load.
- If the unit is used in table top equipment which is plugged into a standard power socket, then it is likely that compliance to the commercial and light industrial emissions standard is required. In this case to meet the conducted emissions requirement, a suitable mains filter should be installed.

Routing of wires

To minimise the pick-up of electrical noise, the low voltage DC connections and the sensor input wiring should be routed away from high-current power cables. Where it is impractical to do this, use shielded cables with the shield grounded at both ends. In general keep cable lengths to a minimum.

4. Switch On

The way in which the controller starts up depends on factors described below in sections 4.1, 4.2 and 4.3.

4.1 New Controller

If the controller is new AND has not previously been configured it will start up showing the 'Quick Configuration' codes. This is a built in tool which enables you to configure the input type and range, the output functions and the display format.



Incorrect configuration can result in damage to the process and/or personal injury and must be carried out by a competent person authorised to do so. It is the responsibility of the person commissioning the controller to ensure the configuration is correct

4.1.1 Quick Start Code

The quick start code consists of two 'SETS' of five characters. The upper section of the display shows the set selected, the lower section shows the five digits which make up the set.



SET 1



Input type		Range		Input/Output 1		Output 2		Output 4	
Thermocouple		Full range		X	Unconfigured				
B	Type B	C	°C	H	PID Heating [logic, relay (1) or 4-20mA] or motor valve open [VC and VP only]				Note (1) O/P4 is relay only.
J	Type J	F	°F	C	PID Cooling [logic, relay (1) or 4-20mA] or motor valve close [VC and VP only]				
K	Type K	Centigrade		J	ON/OFF Heating [logic or relay (1)], or PID 0-20mA heating				
L	Type L	0	0-100	K	ON/OFF Cooling [logic or relay (1)], or PID 0-20mA cooling				
N	Type N	1	0-200	Alarm (2): energised in alarm		Alarm (2): de-energised in alarm		Note (2) OP1 = alarm 1 OP2 = alarm 2 OP3 = alarm 3 OP4 = alarm 4	
R	Type R	2	0-400	0	High alarm	5	High alarm		
S	Type S	3	0-600	1	Low alarm	6	Low alarm		
T	Type T	4	0-800	2	Deviation high	7	Deviation high		
C	Custom	5	0-1000	3	Deviation low	8	Deviation low		
RTD		6	0-1200	4	Deviation band	9	Deviation band		
P	Pt100	7	0-1400	DC Retransmission (not O/P4)					
Linear		8	0-1600	D	4-20mA Setpoint	N	0-20mA Setpoint		
M	0-80mV	9	0-1800	E	4-20mA Temperature	Y	0-20mA Temperature		
2	0-20mA	Fahrenheit		F	4-20mA output	Z	0-20mA output		
4	4-20mA	G	32-212	Logic input functions (Input/Output 1 only)					
		H	32-392	W	Alarm acknowledge	V	Recipe 2/1 select		
		J	32-752	M	Manual select	A	Remote UP button		
		K	32-1112	R	Timer/program run	B	Remote DOWN button		
		L	32-1472	L	Keylock	G	Timer/Prog Run/Reset		
		M	32-1832	P	Setpoint 2 select	I	Timer/Program Hold		
		N	32-2192	T	Timer/program Reset	Q	Standby select		
		P	32-2552	U	Remote SP enable				
		R	32-2912						
		T	32-3272						

Adjust these as follows:-

1. Press any button. The characters will change to '-', the first one flashing.
2. Press ▲ or ▼ to change the flashing character to the required code shown in the quick code tables – see below. Note: An " indicates that the option is not fitted.
3. Press ⌂ to scroll to the next character.

☺ You cannot scroll to the next character until the current character is configured.

☺ To return to the first character press ⌂

4. When all five characters have been configured the display will go to Set 2.

5. When the last digit has been entered press ⌂ again, the display will show



Press ▲ or ▼ to

The controller will then automatically go to the operator level, section 4.3.

SET 2



Input CT Scaling		Digital Input A		Digital Input B (2)		Output 3 (2)				Lower Display			
X	Unconfigured	X	Unconfigured	X	Unconfigured	X	Unconfigured			T	Setpoint (std)		
1	10 Amps	W	Alarm acknowledge			H	PID heating or motor valve open (3)			P	Output		
2	25 Amps	M	Manual select			C	PID cooling or motor valve close (3)			R	Time remaining		
5	50 Amps	R	Timer/Program Run			J	ON/OFF heating (not shown if VC or VP)			E	Elapsed time		
6	100 Amps	L	Keylock			K	ON/OFF cooling (not shown if VC or VP)			1	Alarm setpoint		
		P	Setpoint 2 select			Alarm Outputs (1)				A	Load Amps		
		T	Timer/Program reset			Energised in alarm		De-energised in alarm		D	Dwell/Ramp		
		U	Remote SP enable			0	High alarm	5	High alarm		Time/Target		
		V	Recipe 2/1 select			1	Low alarm	6	Low alarm	N	None		
		A	Remote UP button			2	Dev High	7	Dev High	C	Setpoint with		
		B	Remote DOWN button			3	Dev Low	8	Dev Low		Output meter (2)		
		G	Timer/Prog Run/Reset			4	Dev Band	9	Dev Band	M	Setpoint with		
		I	Timer/Program Hold			DC outputs					Ammeter (2)		
		Q	Standby select			H	4-20mA heating						
						C	4-20mA cooling						
						J	0-20mA heating						
						K	0-20mA cooling						
						<i>Retransmission output</i>							
						D	4-20 Setpoint						
						E	4-20 Measured Temperature						
						F	4-20mA output						
						N	0-20 Setpoint						
						Y	0-20 Measured Temperature						
						Z	0-20mA output						

Note (1)

OP1 = alarm 1 (I/O1)

OP2 = alarm 2

OP3 = alarm 3

OP4 = alarm 4 (AA)

Note (2)

3208 & 3204 only

Note (3)

VP, VC only

4.2 To Re-Enter Quick Code mode

If you need to re-enter the 'Quick Configuration' mode this can always be done as follows:-

1. Power down the controller
2. Hold down the button, and power up the controller again.
3. Keep the button pressed until `CODE` is displayed.
4. Enter the configuration code (this is defaulted to 4 in a new controller)
5. The quick start codes may then be set as described previously

☺ Parameters may also be configured using a deeper level of access. This is described in later chapters of this handbook.

☺ If the controller is started with the button held down, as described above, and the quick start codes are shown with dots (e.g. J.C.X.X.X), this indicates that the controller has been re-configured in a deeper level of access and, therefore, the quick start codes may not be valid. If the quick start codes are accepted by scrolling to

to then the quick start codes are reinstated.

4.3 Pre-Configured Controller or Subsequent Starts

A brief start up sequence consists of a self test during which the software version number is shown followed briefly by the quick start codes.

It will then proceed to **Operator Level 1..**

You will see the display shown below. It is called the HOME display.

The ALM beacon will show red if an alarm is present.

The OP4 beacon will be on if output 4 is active







Measured Temperature (or Process Value 'PV')
Target Temperature (Setpoint 'SP')

☺ If the quick start codes do not appear during this start up, it means that the controller has been configured in a deeper level of access, see the note in section 4.2. The quick start codes may then not be valid and are therefore not shown.

4.4 Front Panel Layout

- ALM Alarm active (Red)
- OP1 lit when output 1 is ON (normally heating)
- OP2 lit when output 2 is ON (normally cooling)
- OP3 lit when output 3 is ON
- OP4 lit when output 4 relay is ON (normally alarm)
- SPX Alternative setpoint in use (e.g. setpoint 2)
- REM Remote digital setpoint. Also flashes when digital communications active
- RUN Timer/programmer running
- RUN (flashing) Timer/programmer in hold
- MAN Manual mode selected

Operator Buttons:-

-  From any view - press to return to the HOME display
-  Press to select a new parameter. If held down it will continuously scroll through parameters.
-  Press to decrease a value
-  Press to increase a value

4.4.2 Alarms

Process alarms may be configured using the Quick Start Codes section 4.1.1. Each alarm can be configured for:-

Full Scale Low	The alarm is shown if the process value falls below a set threshold
Full Scale High	The alarm is shown if the process value rises above a set threshold
Deviation Low	The alarm is shown if the process value deviates below the setpoint by a set threshold
Deviation High	The alarm is shown if the process value deviates above the setpoint by a set threshold
Deviation Band	The alarm is shown if the process value deviates above or below the setpoint by a set threshold

If an alarm is not configured it is not shown in the list of level 2 parameters, section 5.3.

Additional alarm messages may be shown such as CONTROL LOOP BROKEN. This occurs if the controller does not detect a change in process value following a change in output demand after a suitable delay time.

Another alarm message may be INPUT SENSOR BROKEN (Sbr). This occurs if the sensor becomes open circuit; the output level will adopt a 'SAFE' value which can be set up in Operator Level 3, see section 11.2.

 From firmware version 2.11 two further alarm types have been made available. These are:-

Rising rate of change	An alarm will be detected if the rate of change (units/minute) in a positive direction exceeds the alarm threshold
Falling rate of change	An alarm will be detected if the rate of change (units/minute) in a negative direction exceeds the alarm threshold



These alarms cannot be configured by the Quick Start Code – they can only be configured in Configuration Mode, see section 12.3.



- Measured Temperature (or Process Value 'PV')
- Target Temperature (Setpoint 'SP')
- Meter (3208 and 3204 only) –configurable as:
 - Off
 - Heat or cool output
 - Output (Centre zero)
 - Load Amps from CT
 - Error signal

4.4.1 To Set The Target Temperature.



From the HOME display:-

- Press  to raise the setpoint
- Press  to lower the setpoint

The new setpoint is entered when the button is released and is indicated by a brief flash of the display.

4.4.3 Alarm Indication

If an alarm occurs, the red ALM beacon will flash. A scrolling text message will describe the source of the alarm. Any output (usually a relay) attached to the alarm will operate. An alarm relay can be configured using the Quick Start Codes to be energised or de-energised in the alarm condition. It is normal to configure the relay to be de-energised in alarm so that an alarm is indicated if power to the controller fails.

Press  and  (ACK) together to acknowledge

If the alarm is still present the ALM beacon will light continuously otherwise it will go off.

The action which takes place depends on the type of alarm configured:-

- Non latching A non latching alarm will reset itself when the alarm condition is removed. By default alarms are configured as non-latching, de-energised in alarm.
- Auto Latching An auto latching alarm requires acknowledgement before it is reset. The acknowledgement can occur BEFORE the condition causing the alarm is removed.
- Manual Latching The alarm continues to be active until both the alarm condition is removed AND the alarm is acknowledged. The acknowledgement can only occur AFTER the condition causing the alarm is removed.

By default alarms are configured as non-latching, de-energised in alarm. To configure latched alarms, refer to section 12.3.1.

Note: If remote setpoint is configured ensure that the remote input is connected or the relevant rear terminals are linked. If the remote setpoint input is left open circuit the alarm beacon will light.

4.4.4 Auto, Manual and Off Mode



The controller can be put into Auto, Manual or Off mode – see next section.

Auto mode is the normal operation where the output is adjusted automatically by the controller in response to changes in the measured temperature.

In Auto mode all the alarms and the special functions (auto tuning, soft start, timer and programmer) are operative

Manual mode means that the controller output power is manually set by the operator. The input sensor is still connected and reading the temperature but the control loop is 'open'.

In manual mode the MAN beacon will be lit, Band and deviation alarm are masked, the auto-tuning timer and programmer functions are disabled.

The power output can be continuously increased or decreased using the  or  buttons.







 **Manual mode must be used with care. The power level must not be set and left at a value that can damage the process or cause over-heating. The use of a separate 'over-temperature' controller is recommended.**

Off mode means that the heating and cooling outputs are turned off. The process alarm and analogue retransmission outputs will, however, still be active while Band and deviation alarm will be OFF.

4.4.5 To Select Auto, Manual or Off Mode

Press and hold  and  (Mode) together for more than 1 second.

This can only be accessed from the HOME display.

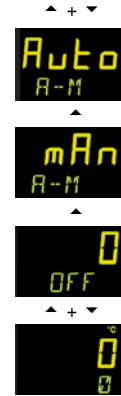

1. 'Auto' is shown in the upper display. After 5 seconds the lower display will scroll the longer description of this parameter. ie 'LOOP MODE - AUTO MANUAL OFF'.
 2. Press  to select 'mAn'. Press again to select 'OFF'. This is shown in the upper display.
 3. When the desired Mode is selected, do not push any other button. After 2 seconds the controller will return to the HOME display.
 4. If OFF has been selected, OFF will be shown in the lower display and the heating and cooling outputs will be off
 5. If manual mode has been selected, the MAN beacon will light. The upper display shows the measured temperature and the lower display the demanded output power.
-  The transfer from Auto to manual mode is 'bumpless'. This means the output will remain at the current value at the point of transfer. Similarly when transferring from Manual to Auto mode, the current value will be used. This will then slowly change to the value demanded automatically by the controller.
6. To manually change the power output, press  or  to lower or raise the output. The output power is continuously updated when these buttons are pressed
 7. To return to Auto mode, press  and  together. Then press  to select 'Auto'.



4.4.6 Level 1 Operator Parameters

A minimal list of parameters are available in operator Level 1 which is designed for day to day operation. Access to these parameters is not protected by a pass code.

Press  to step through the list of parameters. The mnemonic of the parameter is shown in the lower display. After five seconds a scrolling text description of the parameter appears.

The value of the parameter is shown in the upper display. Press  or  to adjust this value. If no key is pressed for 30 seconds the controller returns to the HOME display



The parameters that appear depend upon the functions configured. They are:-

Parameter Mnemonic	Scrolling Display and Description	Alterability
WRK.OP	WORKING OUTPUT The active output value	Read only. Appears when the controller is in AUTO or OFF mode. In a motorised valve controller (option VC or VP) this is the 'inferred' position of the valve
WKG.SP	WORKING SETPOINT The active setpoint value.	Read only. Only shown when the controller is in MAN or OFF mode.
SP1	SETPOINT 1	Alterable
SP2	SETPOINT 2	Alterable
T.REMN	TIME REMAINING Time to end of set period	Read only 0:00 to 99.59 hh:mm or mm:ss
DWELL	SET TIME DURATION Timer set time	Alterable. Only shown if timer (not programmer) configured.
A1.xxx	ALARM 1 SETPOINT	Read only. Only shown if the alarm is configured. xxx = alarm type as follows:- HI = High alarm LO = Low alarm d.HI = Deviation high d.LO = Deviation low d.HI = Deviation high rrc = Rising rate of change (units/minute) Frc = Falling rate of change (units/minute)
A2.xxx	ALARM 2 SETPOINT	
A3.xxx	ALARM 3 SETPOINT	
A4.xxx	ALARM 3 SETPOINT	
LD.AMP	LOAD CURRENT	Read only. Only shown if CT is configured

5. Operator Level 2



Level 2 provides access to additional parameters. Access to these is protected by a security code.

5.1 To Enter Level 2



1. From any display press and hold .
2. After a few seconds the display will show:-
3. Release .



(If no button is pressed for about 45 seconds the display returns to the HOME display)



4. Press  or  to choose LEU 2 (Level 2)
5. After 2 seconds the display will show:-



6. Press  or  to enter the pass code. Default = '2'
- If an incorrect code is entered the controller reverts to Level 1.



5.2 To Return to Level 1





1. Press and hold .
2. Press  to select LEU 1

The controller will return to the level 1 HOME display.

Note: A security code is not required when going from a higher level to a lower level.

5.3 Level 2 Parameters

Press  to step through the list of parameters. The mnemonic of the parameter is shown in the lower display. After five seconds a scrolling text description of the parameter appears.

The value of the parameter is shown in the upper display. Press  or  to adjust this value. If no key is pressed for 30 seconds the controller returns to the HOME display. Backscroll is achieved when you are in this list by pressing  while holding down .

The following table shows a list of parameters available in Level 2.

Mnemonic	Scrolling Display and description	Range	
WKG.SP	WORKING SETPOINT is the active setpoint value and appears when the controller is in Manual mode. It may be derived from SP1 or SP2, or, if the controller is ramping (see SP.RAT), it is the current ramp value.	SP.HI to SP.LO	
WRK.OP	WORKING OUTPUT is the output from the controller expressed as a percentage of full output. It appears when the controller is in Auto mode. In a motorised valve controller (option VC or VP) this is the 'inferred' position of the valve For a time proportioning output, 50% = relay or logic output on or off for equal lengths of time. For On/Off control: OFF = <1%. ON = >1%	Read only value 0 to 100% for heating 0 to -100% for cooling -100 (max cooling) to 100% (max heating)	
T.STAT	TIMER STATUS is the current state of the timer: Run, Hold, Reset or End It is only appears when a timer is configured.	rES	Reset
		run	Running
		hoLd	Hold
		End	Timed out
UNITS	DISPLAY UNITS Temperature display units. 'Percentage' is provided for linear inputs	°C	Degrees C
		°F	Degrees F
		°K	Degrees K
		nonE	None
		PERc	Percentage
SP.HI	SETPOINT HIGH High setpoint limit applied to SP1 and SP2.	Alterable between range limits	
SP.LO	SETPOINT LOW Low setpoint limit applied to SP1 and SP2		
By default the remote setpoint is scaled between SP.HI and SP.LO. Two further parameters (REM.HI and REM.LO) are available in access level 3 to limit the Remote SP range if required. See section 10.1.			
SP1	SETPOINT 1 allows control setpoint 1 value to be adjusted	Alterable: SP.HI to SP.LO	
SP2	SETPOINT 2 allows control setpoint 2 value to be adjusted	Alterable: SP.HI to SP.LO	
SP.RAT	SETPOINT RATE LIMIT Rate of change of setpoint value.	OFF to 3000 display units per minute	
The next section applies to the Timer only – see also section 5.4.			
TM.CFG	TIMER CONFIGURATION Configures the timer type:- Dwell, Delay, Soft Start or none. The timer type can only be changed when the timer is reset. The Programmer option only appears if the programmer has been ordered.	nonE	None
		dwEIl	Dwell
		dELY	Delayed switch on
		SFSSt	Soft start
		ProG	Programmer
TM.RES	TIMER RESOLUTION Selects the resolution of the timer. This can only be changed when the timer is reset.	Hour mi n	Hours Minutes
THRES	TIMER START THRESHOLD The timer starts timing when the temperature is within this threshold of the setpoint. This provides a guaranteed soak temperature. The threshold can be set to OFF in which case it is ignored and the timing starts immediately. If a setpoint ramping is set, then the ramp completes before the timer starts.	OFF or 1 to 3000	
END.T	TIMER END TYPE This determines the behaviour of the timer when it has timed out. This value can be changed while the timer is running.	OFF	Control OP goes to zero
		dwEIl	Control continues at SP1
		SP2	Go to SP2
		rES	Reset programmer
SS.PWR	SOFT START POWER LIMIT This parameter only appears if the timer configuration is set to SFSSt (Softstart). It sets a power limit which is applied until the measured temperature reaches a threshold value (SS.SP) or the set time (DWELL) has elapsed. The timer starts automatically on power up.	-100 to 100%	

Mnemonic	Scrolling Display and description	Range
SS.SP	SOFT START SETPOINT This parameter only appears if the timer configuration is set to <i>SFSE</i> (Softstart). It sets the threshold value below which the power is limited	Between SP.HI and SP.LO
DWELL	SET TIME DURATION - Sets the dwell timing period. It can be adjusted while the timer is running.	0:00 to 99.59 hh:mm: or mm:ss
T.REMN	TIME REMAINING Timer time remaining. This value can be increased or decreased while the timer is running	0:00 to 99.59 hh:mm: or mm:ss
The following parameters are available when the timer is configured as a programmer – see also section 13.2		
SERVO	SERVO MODE. Sets the starting point for the ramp/dwell programmer and the action on recovery from power failure.	<i>SP</i> Setpoint
		<i>PU</i> Process variable
		<i>SPrb</i> Ramp back to SP
		<i>PURb</i> Ramp back to PV
TSP.1	TARGET SETPOINT 1. To set the target value for the first setpoint	
RMP.1	RAMP RATE 1. To set the first ramp rate	OFF, 0:01 to 3000 units per min or hour as set by TM.RES
DWEL.1	DWELL 1. To set the period of the first dwell	OFF, 0:01 to 99:59 hh:mm or mm:ss as set by TM.RES
The above three parameters are repeated for the next three program segments, i.e. TSP.2 (3 & 4), RMP.2 (3 & 4), DWEL.2 (3 & 4)		
This section applies to Alarms only If an alarm is not configured the parameters do not appear		
A1.--- - to A4.---	ALARM 1 (2, 3 or 4) SETPOINT sets the threshold value at which an alarm occurs. Up to four alarms are available and are only shown if configured. The last three characters in the mnemonic specify the alarm type:-	SP.HI to SP.LO
		<i>L O</i> Full Scale Low <i>H I</i> Full Scale High
		<i>DH I</i> Deviation High <i>DL O</i> Deviation Low <i>DN D</i> Deviation Band
	<i>RR C</i> Rising rate of change <i>FR C</i> Falling rate of change	1 to 9999 units/minute
The following parameter is present if a motorised valve controller has been ordered		
MTR.T	MOTOR TRAVEL TIME. Set this value to the time that it takes for the motor to travel from its fully closed to its fully open position. Note: In motorised valve control only the PB and TI parameters are active – see below. The TD parameter has no effect on the control.	<i>00</i> to <i>999.9</i> seconds
This section applies to control the parameters. A further description of these parameters is given in section 11		
A.TUNE	AUTOTUNE automatically sets the control parameters to match the process characteristics.	<i>OFF</i> Disable <i>On</i> Enable
PB	PROPORTIONAL BAND sets an output which is proportional to the size of the error signal. Units may be % or display units.	1 to 9999 display units Default 20
TI	INTEGRAL TIME removes steady state control offsets by ramping the output up or down in proportion to the amplitude and duration of the error signal.	<i>OFF</i> to 9999 seconds Default 360
TD	DERIVATIVE TIME determines how strongly the controller will react to the rate of change in the process value. It is used to prevent overshoot and undershoot and to restore the PV rapidly if there is a sudden change in demand.	<i>OFF</i> to 9999 seconds Default 60 for PID control Default 0 for VP control
MR	MANUAL RESET applies to a PD only controller i.e. the integral term is turned off. Set this to a value of power output (from +100% heat, to -100% cool which removes any steady state error between SP and PV.	-100 to 100% Default 0
R2G	RELATIVE COOL GAIN adjusts the cooling proportional band relative to the heating proportional band. Particularly necessary if the rate of heating and rate of cooling are very different. (Heat/Cool only)	0.1 to 10.0 Default 1.0
HYST.H	HEATING HYSTERESIS Sets the difference in temperature units between heating turning off and turning on when ON/OFF control is used. Only appears if channel 1(heating) control action is On/Off	0.1 to 200.0 display units 0.2 Default 1.0
HYST.C	COOLING HYSTERESIS Sets the difference in temperature units between cooling turning off and turning on when ON/OFF control is used. Only appears	0.1 to 200.0 display units Default 1.0

Mnemonic	Scrolling Display and description	Range																
	if channel 2 (cooling) control action is On/Off																	
D.BAND	CHANNEL 2 DEADBAND adjusts a zone between heating and cooling outputs when neither output is on. Off = no deadband. 100 = heating and cooling off. Only appears if On/Off control configured.	OFF or 0.1 to 100.0% of the cooling proportional band																
OP.HI	OUTPUT HIGH limits the maximum heating power applied to the process or a minimum cooling output.	+100% to OP.LO																
1. (2, 3 or 4) PLS.	OUTPUT 1 (2, 3 or 4) MINIMUM PULSE TIME Sets the minimum on and off time for the control output.  Ensure this parameter is set to a value that is suitable for the output switching device in use. For example, if a logic output is used to switch a small relay, set the value to 5.0 seconds or greater to prevent damage to the device due to rapid switching.	Relay outputs 0.1 to 150.0 seconds – default 5.0. Logic outputs Auto to 150.0 - Default Auto = 55ms																
This section applies to current transformer input only. If the CT option is not configured the parameters do not appear.																		
LD.AMP	LOAD CURRENT is the measured load current when the power demand is on	CT Range																
LK.AMP	LEAK CURRENT is the measured leakage current when the power demand is off.	CT Range																
LD.ALM	LOAD CURRENT THRESHOLD Sets a low alarm on the load current measured by the CT. Used to detect partial load failure.	CT Range																
LK.ALM	LEAK CURRENT THRESHOLD sets a high alarm on the leakage current measured by the CT.	CT Range																
HC.ALM	OVERCURRENT THRESHOLD Sets a high alarm on the load current measured by the CT	CT Range																
ADDR	ADDRESS - communications address of the controller. 1 to 254	1 to 254																
HOME	HOME DISPLAY Defines the parameter which appears in the lower section of the HOME display.	<table border="1"> <tr> <td>Std</td> <td>Standard</td> </tr> <tr> <td>OP</td> <td>Output power</td> </tr> <tr> <td>Tr</td> <td>Time remaining</td> </tr> <tr> <td>ELAP</td> <td>Time elapsed</td> </tr> <tr> <td>AL</td> <td>First alarm setpoint</td> </tr> <tr> <td>CT</td> <td>Load current</td> </tr> <tr> <td>CLr</td> <td>Clear (blank)</td> </tr> <tr> <td>Emr</td> <td>Combined setpoint and time display</td> </tr> </table>	Std	Standard	OP	Output power	Tr	Time remaining	ELAP	Time elapsed	AL	First alarm setpoint	CT	Load current	CLr	Clear (blank)	Emr	Combined setpoint and time display
Std	Standard																	
OP	Output power																	
Tr	Time remaining																	
ELAP	Time elapsed																	
AL	First alarm setpoint																	
CT	Load current																	
CLr	Clear (blank)																	
Emr	Combined setpoint and time display																	
ID	CUSTOMER ID Sets a number from 0 to 9999 used as a custom defined identification number for the controller.	0 to 9999																
REC.NO	CURRENT RECIPE NUMBER Displays the current recipe number. If this number is changed, the parameter values stored under the selected recipe number will be loaded. See the engineering manual for more information about recipes.	nonE or 1 to 5 or FA L if no recipe set stored																
STORE	RECIPE TO SAVE Saves the current parameter values into a selected recipe number. Up to 5 recipes can be saved.	nonE or 1 to 5 donE when stored																

☺ Press  at any time to return immediately to the HOME screen at the top of the list.

☺ Hold  down to continuously scroll through the above list

5.4 Timer Operation

An internal timer can be configured to operate in one of four different modes. The mode is configured in Level 2 by the 'TM.CFG' (timer configuration) parameter. Each Timing Mode is described in the pages that follow.

Operation	Action	Indication
To Run the timer	Press and quickly release ⏏ + ⏏	Beacon -- RUN = On Scrolling text display:- TIMER RUNNING
To Hold the timer	Press and quickly release ⏏ + ⏏	Beacon -- RUN = Flashing Scrolling text display:- TIMER HOLD
To Reset the timer	Press and hold ⏏ + ⏏ for more than 1 second	Beacon -- RUN = Off If the timer is a Dwell Type and configured to turn power off at the end of the timing period OFF will be displayed
	Timer has timed out (END state)	Beacon -- RUN = Off SPX = On if End Type = SP2 Scrolling display:- TIMER END. Note:- The timer can be re-run from the end state without the need to reset it.

The timer can also be RUN, HELD or RESET by the parameter 'T.STAT' (Timer status). It can also be controlled via digital inputs (if configured).

5.5 Dwell Timer

A dwell timer ('**TM.CFG**' = '**dwEll**') is used to control a process at a fixed temperature for a defined period.

In reset the controller behaviour depends on the configuration of the END state parameter. See opposite.

In run the heating or cooling will come on. Timing starts when the temperature is within the threshold '**THRES**' of the setpoint. If the threshold is set to OFF the timing starts immediately.

If setpoint ramping is enabled, then the ramp completes before the timer starts.

In the END state the behaviour is determined by the parameter '**END.T**' (End type):

OFF The heating and cooling is turned OFF (resets to Off)

dwEll Controls at setpoint1 (resets to Setpoint 1)

SP2 Controls at setpoint 2 (resets to Setpoint 1)

rES Reset reverts to SP1.– (added from version V2.13)

Note: The dwell period can be reduced or increased while the timer is running.

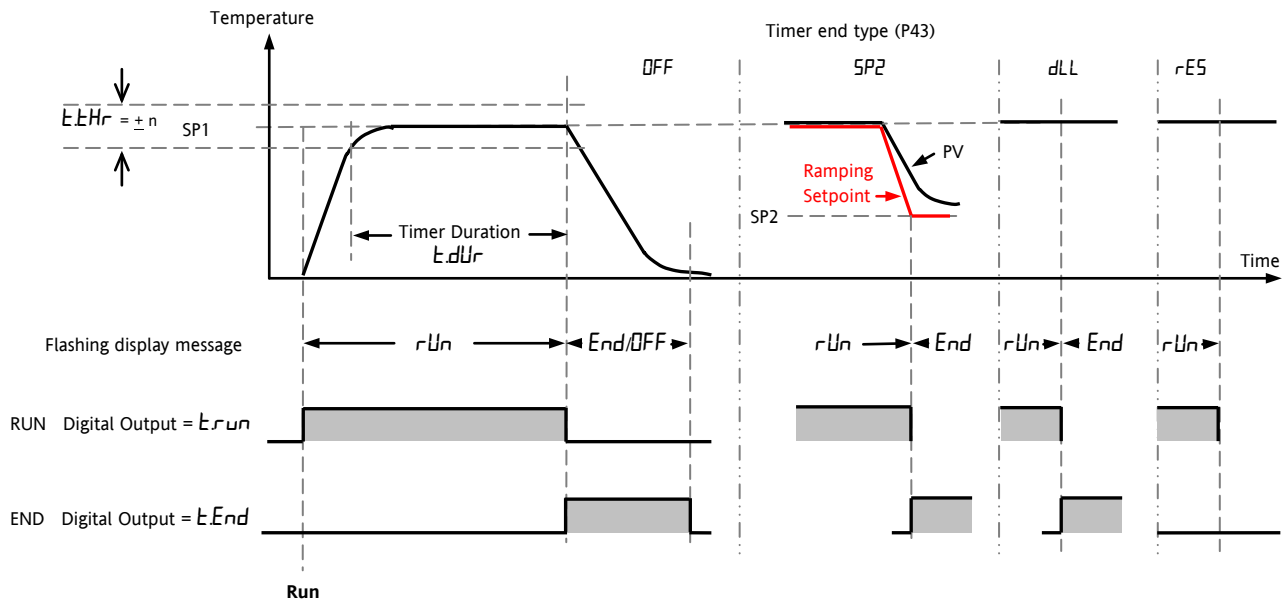

5.6 Delayed Timer

'**TM.CFG**' = '**dELy**'. The timer is used to switch on the output power after a set time. The timer starts immediately on power-up, or when run.

The controller remains in standby with heating and cooling off until the time has elapsed. After the time has elapsed, the instrument controls at the target setpoint.

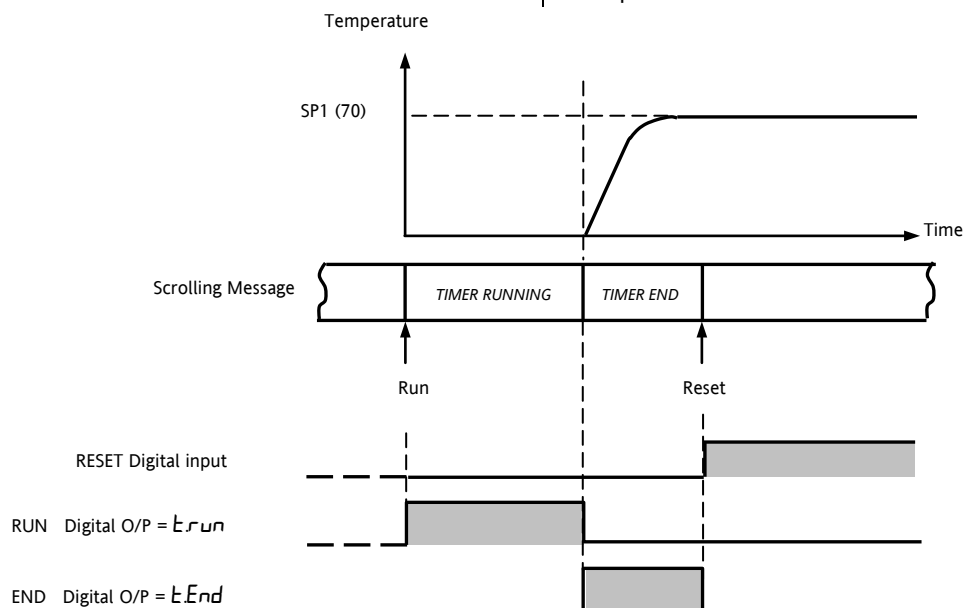

5.7 Soft Start Timer

'TM.CFG' = '55.5t'.

A Soft Start timer starts automatically on power up. It applies a power limit ('SS.PWR') until the temperature reaches a threshold value ('SS.SP') or the timer times-out after the dwell period ('dwell'). It is typically use to dry-out heaters in Hot Runner control systems

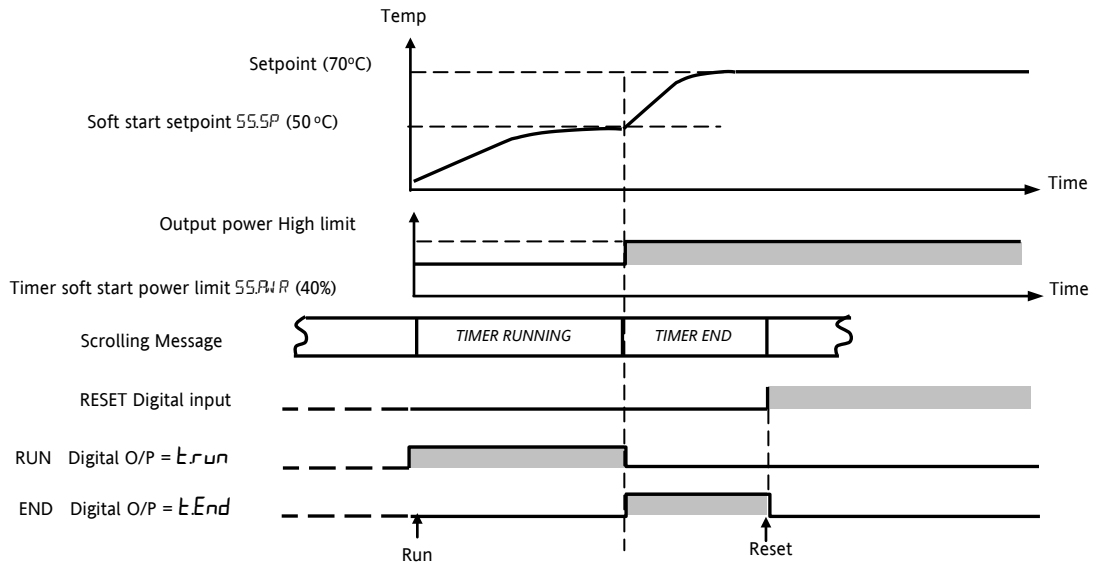

5.8 Programmer

'TM.CFG' = 'ProG'. Function code CP is an eight segment programmer consisting of four ramp/dwell pairs. Each ramp consists of a controlled rate of change of setpoint to a target level. Each ramp is followed by a dwell at that level. The ramp rate, target level and dwell time are set by the user. The program profile is shown in the diagram below.

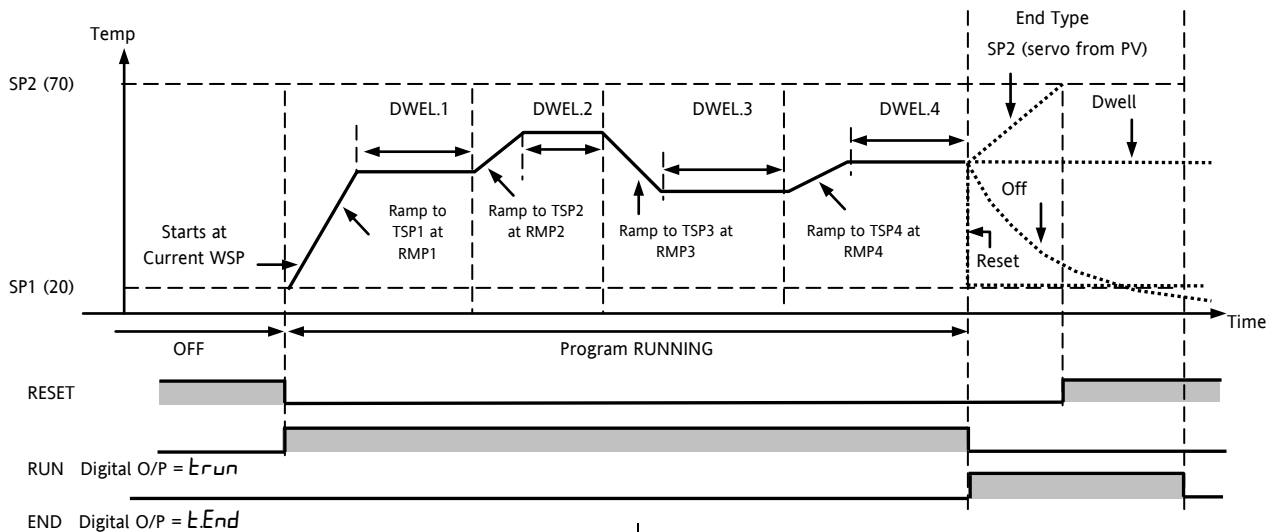

Notes:-

1. When a step change is required, the ramp rate should be set to 'OFF'.
2. Where ramp/dwell pairs are not required, the ramp rate should be set to 'OFF' and the target setpoint, TSP, the same as the preceding segment
3. TIMER END - when the end type is SP2, Timer END does not occur until the ramp is complete or SP2 is achieved. It is more usual to use a DWELL (default) or RESET end type

A single program event output is also available. To use this refer to section 13.2.3.

5.8.1 Programmer Servo Mode and Power Cycling

The way in which the program starts when 'Run' is selected or after the power is turned off and on again, is determined by the SERVO MODE parameter, as follows:-

SERVO MODE	
SP	The program will start from the current setpoint value. On recovery from power failure, the program will reset. It will require to be run again manually. The working setpoint will revert to SP1 or SP2 (depending on which was selected) and the whole program is repeated.
PV	The program will start from the measured temperature . On recovery from power failure, the program will reset. It will require to be run again manually, but it will start at the value of the PV at the point when the programmer is run again.
SP.rb	On recovery from power failure, the program will automatically run at the last ramp rate from the current setpoint value , see the sketches below.
PV.rb	The program will start from the measured temperature . On recovery from power failure, the program will automatically run at the last ramp rate from the current measured temperature , see the sketches below.

The behaviour of the programmer following a power failure is shown graphically below for SERVO = SP.rb and PV.rb:-

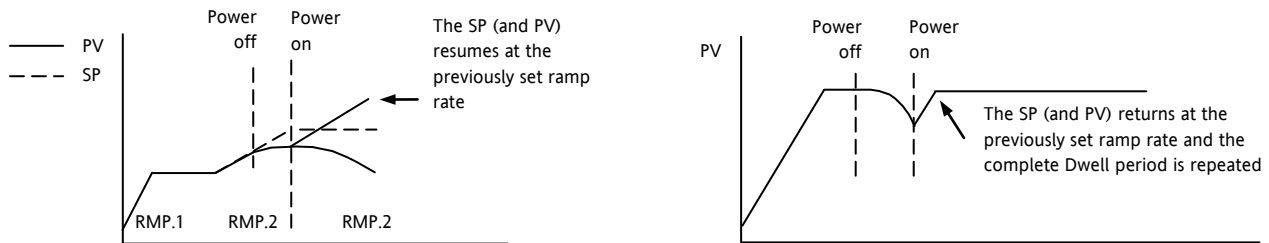

5.8.2 To Operate the Programmer

































Operation of the programmer is the same as the timer.

Operation	Action	Indication
To Run a program	Press and quickly release $\nabla + \blacktriangle$	Beacon -- RUN = On Scrolling display - TIMER RUNNING
To Hold a program	Press and quickly release $\nabla + \blacktriangle$	Beacon -- RUN = Flashing Scrolling display - TIMER HOLD
To Reset a program	Press and hold $\nabla + \blacktriangle$ for more than 1 second	Beacon -- RUN = Off If End Type = Off then OFF will be displayed at the end of the program
	Program ended	Beacon -- RUN = Off SPX = On if End Type = SP2 Scrolling display - TIMER END
Repeat the above to Run the programmer again (Note: it is not essential to reset it after the End state is reached)		

Programs can also be operated from the 'T.STAT' parameter found in the level 2 parameter list.

5.8.3 To Configure the Programmer

Select Access Level 2 – see section 5.

Operation	Action	Indication	Notes
Configure the Timer as a Programmer	1. Press  to select 'TM.CFG' 2. Press  or  to 'Prog'		
Set the Resolution	3. Press  to select 'TM.RES' 4. Press  or  to 'Hour' or 'm n'		In this example the ramp rate and dwell period are set in hours
Set the Threshold	5. Press  to select 'THRES' 6. Press  or  to adjust		In this example the dwell periods will not start until the PV is within 5 units of the setpoint
Set the action when the programmer times out	7. Press  to select 'END.T' 8. Press  or  to 'OFF', or 'SP2' or 'dwell' or 'rSt'		In this example the controller will continue to control indefinitely at the last setpoint. OFF will turn the output power. SP2 will control at setpoint 2 Reset will control at the selected setpoint
Set the Servo Mode	9. Press  to select 'SERVO' 10. Press  or  to 'PU', 'SP', 'SPrb', or 'PUrb'		In this example the program will start from the current value of the process temperature. See also section 5.8.1.
Set the first Target Setpoint	11. Press  to select 'TSP.1' 12. Press  or  to adjust		In this example the setpoint will ramp from the current value of the PV to the first target - 100
Set the first Ramp Rate	13. Press  to select 'RMP.1' 14. Press  or  to adjust		In this example the setpoint will ramp to 100 at 8.0 units per hour
Set the first Dwell	15. Press  to select 'DWEL.1' 16. Press  or  to adjust		In this example the setpoint will remain at the start value for 2 hours 11 minutes
Repeat the above three steps for all segments			

Notes:-

- It is possible to set, in a deeper level of access, Event Outputs and Programmer Cycles. See sections 13.2.3 and 13.2.4.
- 'Event Outputs' is available in software version 2 and above. A digital event may be configured to operate in any segment of the program. This event may be configured to operate a digital output.
- 'Programmer Cycles' is available from software versions 2.09 (PID controllers) and 2.29 (Valve Position controllers). This allows the programmer to repeat the set program up to 100 times.

6. Access to Further Parameters

6.1 Parameter Levels

Parameters are available under different levels of security and are defined as Level 1 (LEV 1), Level 2 (LEV 2), Level 3 (LEV 3) and Configuration (CONF).

Level 1 has no passcode since it contains a minimal set of parameters generally sufficient to run the process on a daily basis.

Level 2 allows access to parameters which may be used in commissioning a controller or settings between different products or batches.

Level 1 and Level 2 operation has been described in the previous sections.

Level 3 and Configuration level parameters are also available as follows:-

6.1.1 Level 3

Level 3 makes all operating parameters available and alterable (if not read only). It is typically used when commissioning a controller.

Examples of parameters available in Level 3 are:-
Range limits, setting alarm levels, communications address.

The instrument will continue to control when in Levels 1, 2 or 3.

6.1.2 Configuration Level

This level makes available all parameters including the operation parameters so that there is no need to switch between configuration and operation levels during commissioning. It is designed for those who may wish to change the fundamental characteristics of the instrument to match the process.

Examples of parameters available in Configuration level are:-

Input (thermocouple type); Alarm type;
Communications type.











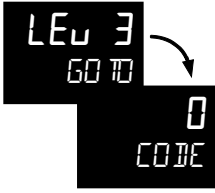



WARNING

Configuration level gives access to a wide range of parameters which match the controller to the process. Incorrect configuration could result in damage to the process being controlled and/or personal injury. It is the responsibility of the person commissioning the process to ensure that the configuration is correct.

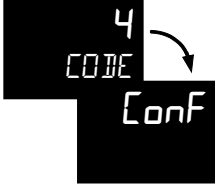

In configuration level the controller is not controlling the process or providing alarm indication. Do not select configuration level on a live process.

Operating Level	Home List	Full Operator	Configuration	Control
Level 1	✓			Yes
Level 2	✓			Yes
Level 3	✓	✓		Yes
Conf	✓	✓	✓	No

6.1.3 To Select Access Level 3 or Configuration Level

Do This	The Display You Should See	Additional Notes
1. From any display press and hold  for more than 5 seconds	<p>To Select Level 3</p> 	<p>The display will pass from the current operating level, for example, <i>LEU 1</i> to <i>LEU 3</i> as the button is held down.</p> <p>(If no button is then pressed for about 50 seconds the display returns to the HOME display)</p>
2. Press  or  to enter the passcode for Level 3		<p>The default code is 3:</p> <p>If an incorrect code is entered the display reverts to 'GO TO':</p> <p>The controller is now in the level 3 will then revert to the HOME display</p>
3. When the <i>LEU3 GO TO</i> view is shown, as in paragraph 1 above, press  to select 'CONF'	<p>To Select Configuration level</p> 	<p>Note:  must be pressed quickly before the controller requests the code for level 3</p>
4. Press  or  to enter the passcode for Configuration level		<p>The default code is 4:</p> <p>If an incorrect code is entered the display reverts to 'GO TO':</p> <p>The controller is now in Configuration level will now show <i>CONF</i></p>
5. Press and hold  for more than 3 seconds	<p>To Return to a Lower Level</p> 	<p>The choices are:</p> <p><i>LEU 1</i> Level 1 <i>LEU 2</i> Level 2 <i>LEU 3</i> Level 3 <i>CONF</i> Configuration</p> <p>It is not necessary to enter a code when going from a higher level to a lower level.</p> <p>Alternatively, press  and scroll to the <i>ACCESS</i> list header, then press  to select the required level.</p> <p>The display will then flash 'CONF' for a few seconds and the controller will then go through its start up sequence, starting in the level selected.</p> <p>Do not power down while <i>CONF</i> is flashing. If a power down does occur an error message will appear – see section 12.4 'Diagnostic Alarms'</p>
6. Press  to select the required level eg <i>LEU 1</i>		

 A special case exists if a security code has been configured as '0'. If this has been done it is not necessary to enter a code and the controller will enter the chosen level immediately.

 When the controller is in configuration level the ACCESS list header can be selected from any view by holding down the  button for more than 3 seconds. Then press  again to select 'ACCESS'

6.2 Parameter lists

Parameters are organised in lists. The top of the list shows the list header only. The name of the list header describes the generic function of the parameters within the list. For example, the list header 'ALARM' contains parameters which enable you to set up alarm conditions.

6.2.1 To Choose Parameter List Headers

Press . Each list header is selected in turn every time this key is pressed.

The name of the list header appears in the lower display, followed, after a few seconds, by a scrolling longer description of the name.

The following example shows how to select the first two list headers. (Views are shown for 3216 controllers).

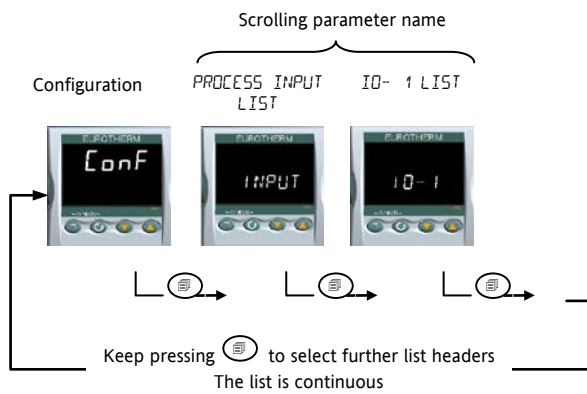

6.2.2 To Locate a Parameter

Choose the appropriate list, then press . Each parameter in the list is selected in turn each time this button is pressed. The following example shows how to select the first two parameters in the ALARM List. All parameters in all lists follow the same procedure. (Views are shown for 3216 controllers).

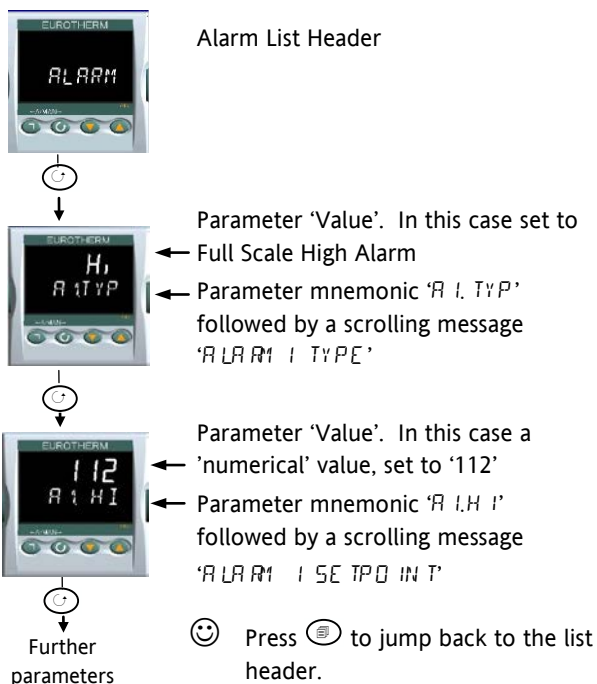

6.2.3 How Parameters are Displayed

As shown above, whenever a parameter is selected it is displayed as a mnemonic, of four or five characters, for example 'A1TYP'.

After a few seconds this display is replaced by a scrolling banner which gives a more detailed description of the parameter. In this example 'A1TYP' = 'ALARM 1 TYPE'. The scrolling banner is only shown once after the parameter is first accessed. (Views are shown for 3216 controllers).

The name of the list header is also displayed in this way.

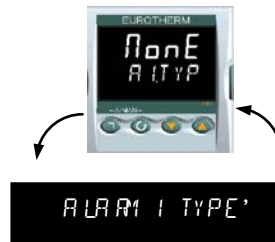

The upper part of the display shows the value of the parameter.

The lower part shows its mnemonic followed by the scrolling name of the parameter

6.2.4 To Change a Parameter Value

With the parameter selected, press to increase the value, press to decrease the value. If either key is held down the analogue value changes at an increasing rate.

The new value is entered after the key is released and is indicated by the display blinking. The exception to this is output 'Power' when in manual. In this case the value is entered continuously.

The upper display shows the parameter value the lower display shows the parameter name.

6.2.5 To Return to the HOME Display

Press + .

On release of the keys the display returns to the HOME list. The current operating level remains unchanged.

6.2.6 Time Out

A time out applies to the 'Go To' and 'Control Mode' parameters. If no key presses are detected within a period of 5 seconds the display will revert back to the HOME list.

Press and hold to scroll parameters forward through the list. With depressed, press to scroll parameters backward.

6.3 Navigation Diagram

The diagram below shows the all list headings available in configuration level for 3216 controllers.

The parameters in a list are shown in tables in the following sections of this manual together with explanations of their meanings and possible use.

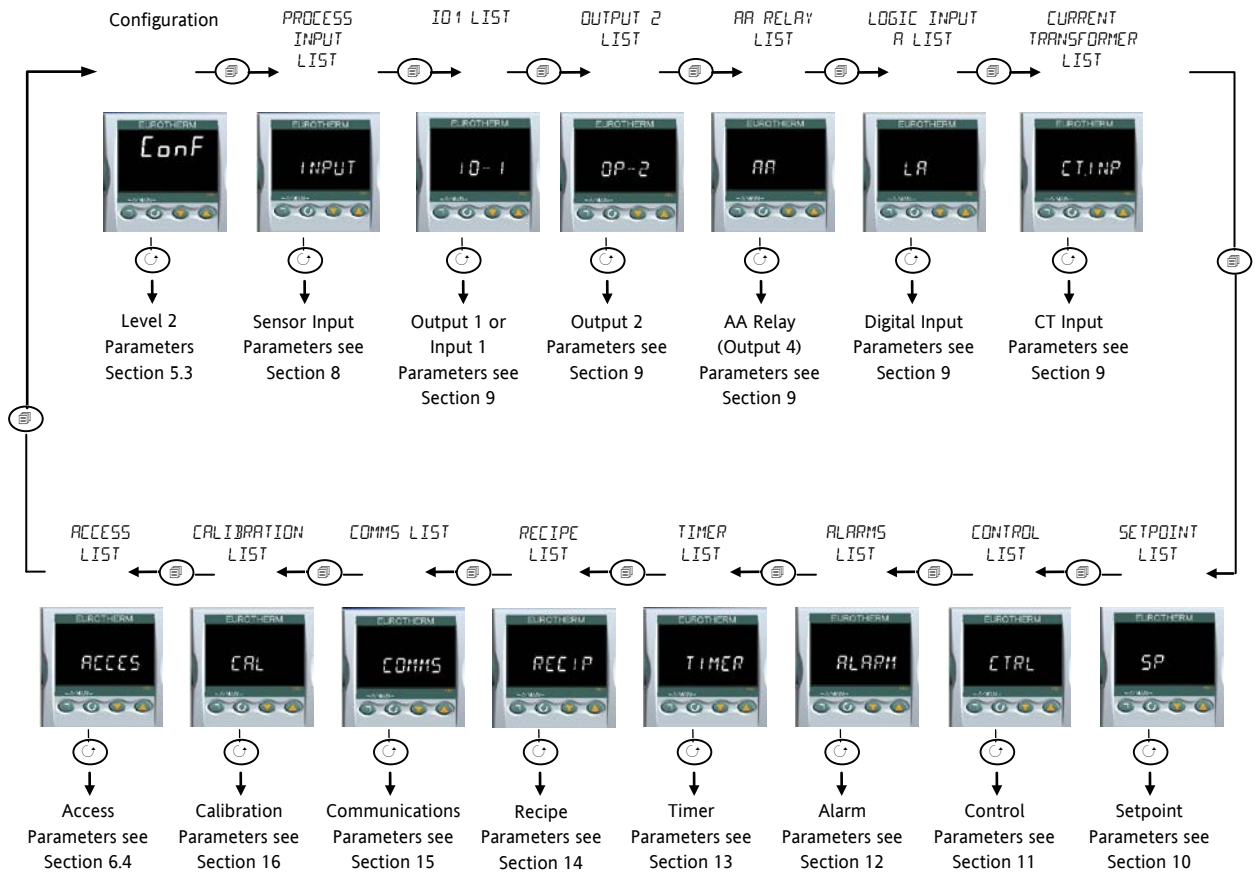











For 3208 and 3204 controllers additional lists are available, for example Output 3 and Digital Input B

6.4 Access Parameters

The following table summarises the parameters available under the ACCESS list header



The Access List can be selected at any time when in configuration level by holding  key down for 3 seconds, then press  or  with  still held down.

ACCESS LIST		'ACCESS'				
Name	Scrolling Display	Parameter Description	Values Allowed		Default	Access Level
GOTO	SELECT ACCESS LEVEL	Allows you to change the access level of the controller. Passwords prevent unauthorised change	LEU.1	Operator level 1	LEU.1	Conf
			LEU.2	Operator level 2		
			LEU.3	Operator level 3		
			CONF	Configuration level		
LEV2P	LEVEL 2 PASSCODE	The Level 2 passcode	0-9999		2	Conf
LEV3P	LEVEL 3 PASSCODE	The Level 3 passcode	0 = no passcode will be requested		3	Conf
CONF.P	CONFIG PASSCODE	To set a Configuration level passcode			4	Conf
ID	CUSTOMER ID	To set the identification of the controller	0-9999			Conf
HOME	HOME DISPLAY See Note 1	To configure the parameter to be displayed in the lower line of the HOME display	Setd	Setpoint	Setd	Conf
			OP	Output demand		
			Er	Time remaining		
			ELAP	Time elapsed		
			AL	Alarm 1 setpoint		
			CT	Current transformer		
			CLr	No parameter		
			Emr	Time remaining		
			ESP	Target setpoint		
			no.PU	PV is not displayed		
			StBY	PV is not displayed when the controller is in standby mode		
K.LOCK	KEYBOARD LOCK	To limit operation of the front panel buttons when in operator levels.  If ALL has been selected, then to restore access to the keyboard, power up the controller with the  button held down and enter the configuration level passcode as described in section 6.1.3. This will take you to the Quick Code mode. Press  to Exit and select YES. The front panel buttons can then be operated as normal.	nonE	Unlocked	nonE	Conf
			ALL	All buttons locked		
			Edi t	Edit keys locked See Note 2		
			mod	Mode keys locked See Note 3		
			mAn	Manual mode locked		
			StBY	Press  and  to toggle between normal operation and standby mode		
			Emr	Prevents Auto/Manual/Off but allow timer operation using  and 		
COLD	COLD START ENABLE/ DISABLE	Use this parameter with care. When set to yes the controller will return to factory settings on the next power up	no	Disable	no	Conf
			YES	Enable		
STBY.T	STANDBY TYPE	Turn ALL outputs off when the controller is in standby mode. Typical use when event alarms are used to interlock a process.	AbSA	Absolute alarms to remain active	AbSA	Conf
			OFF	All alarms off in standby		
PASS.1	FEATURE PASSCODE	To select chargeable features		Contact Eurotherm. Note 5		Conf
PASS.2	FEATURE PASSCODE	To select chargeable features				Conf
METER	METER CONFIGURATION See Note 4	To configure the analogue meter to indicate any one of the parameters listed. This is only applicable to 3208 and 3204 controllers.	OFF	Meter display disabled		Conf
			HEAT	Heat Output demand		
			COOL	Cool output demand		
			w.SP	Working setpoint		
			PU	Process value		
			OP	Heat output demand		
			COOL	Cool output demand		
			Err	Error (SP – PV)		
			AmPS	Output current		
LCur	Load current from CT					

Note 1**Home Display Configuration**

The upper display always shows PV, the lower display is configurable.

Setd In automatic control the lower display shows setpoint. In manual mode output power is shown.

OP Output power is shown in both automatic and manual modes.

Tr Timer time remaining

ELAP Timer elapsed time.

AL 1 First configured alarm setpoint

CT CT current

CLr Blank display

Emr The display shows setpoint while the timer is not running and time remaining when the timer is active.

ESp The display shows target setpoint so that the target for a ramp may be viewed rather than the current working setpoint

noPu The upper display is blank

SEbY The upper display blanks when the controller is in standby mode.

Note 2

Edit keys locked. Parameters cannot be changed but viewed only. However, it is possible to run, hold and reset timer and acknowledge alarms.

Note 3

Mode key locked. Timer run, hold, reset and Auto/Manual cannot be operated from the Mode key. The following sections in this handbook describe the parameters associated with each subject. The general format of these sections is a description of the subject, followed by the table of all parameters to be found in the list, followed by an example of how to configure or set up parameters.

Note 4**Meter Configuration**

HEAL The meter shows a representation of the heat output being applied by the control loop to the load. It is scaled between 0 and 100% full scale deflection.

OP The meter displays the current Control Output setting scaled between the low and high output power limits. In a motorised valve controller (option VC or VP) this is the 'inferred' position of the valve

COOL The meter shows a representation of the cool output being applied by the control loop to the load. It is scaled between 0 and 100% full scale deflection.

COOP The meter displays the current output power setting scaled between -100 and 100%, so that a value of zero is centred in the display. This indicates whether the controller is currently applying heating or cooling.

w.SP The meter shows a representation of the current working setpoint, scaled between the setpoint high and low limits. It may be used to indicate at what point in the setpoint range the instrument is currently operating.

PV The meter displays the current Process Variable scaled between the range high and low values. Provides an indication of the current temperature relative to the range of a process.

Err The meter displays the process error (i.e. the difference between the current temperature and the setpoint), scaled between +10 degrees and -10 degrees. This provides a visual indication of whether the process is close to setpoint.

Amps The meter shows a representation of the instantaneous current through a load monitored using a current transformer, scaled between 0 Amps and the configured range of the Current Transformer. It may be used to visually indicate the health of the heating elements, since in normal use it will tend to flick from a low reading when the heating is off, to a higher reading when the heating is on. If the needle does not return to a low value, the SSR may be conducting regardless of the logic signal driving it. If the needle does not reach the expected level it is likely that one or more of the heater elements has burned out.

LCur The meter displays a representation of the On State Current in a load monitored by the current transformer option. In normal operation it will tend to remain static and provides an alternative means of monitoring the health of a heating element to the 'Amps' option.

Note 5

Feature Passcodes These parameters were added in controllers with software versions 2.09 (PID controller) and 2.29 (VP controller) and above. They allow the controller to be field upgraded with additional chargeable features. To upgrade, contact Eurotherm and provide the existing number codes. 'Pass2' is read only and is required to provide Eurotherm with the current instrument features. You will be given a numeric code to enter as the new 'PassC' parameter.

7. Controller Block Diagram

The block diagram shows the simple building blocks which make up the controller. Each block has a list of parameters headed by a list name. For example the 'Input List' contains parameters which define the input type.

The quick start code automatically sets the parameters to match the hardware.

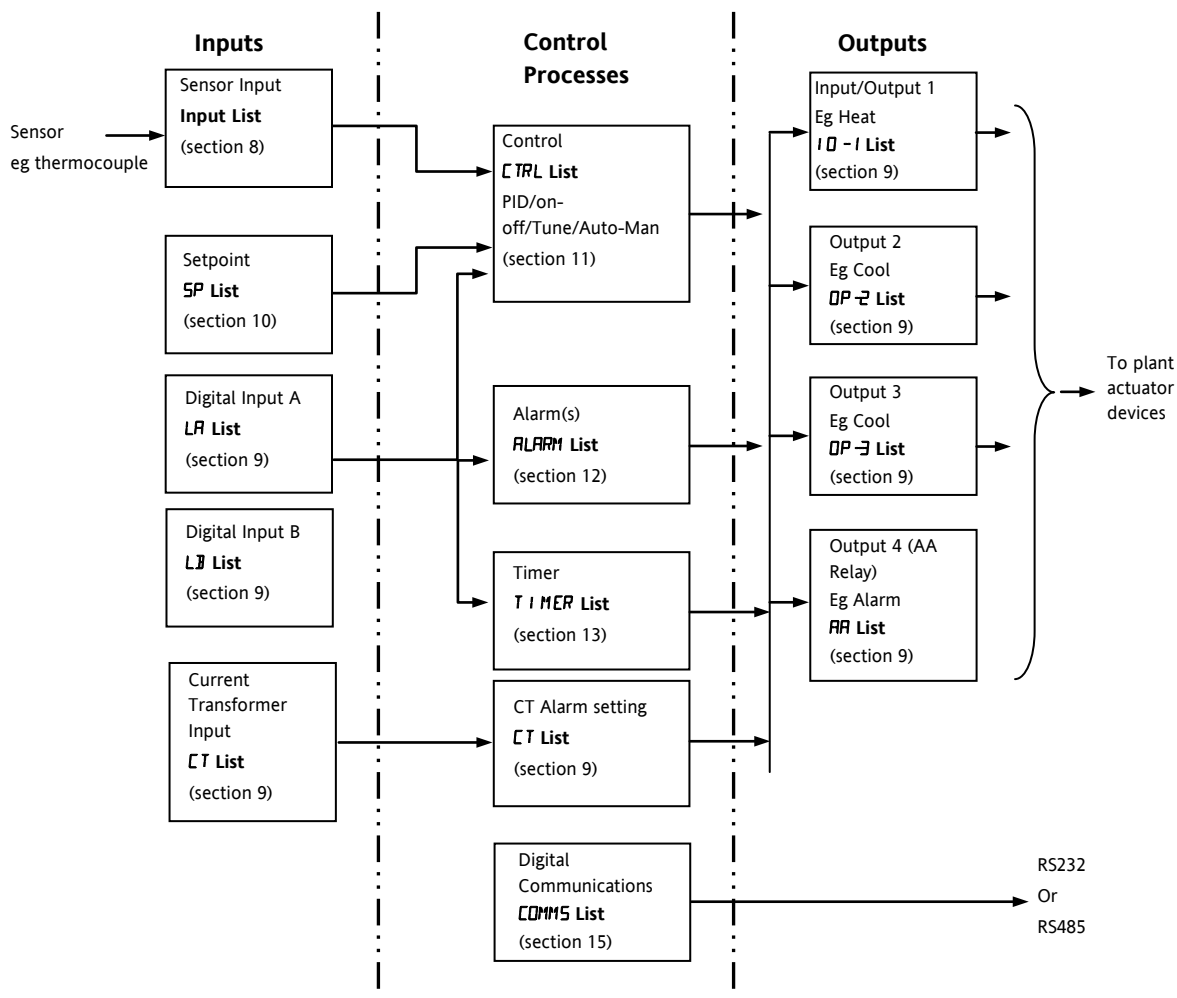

The Temperature (or Process Value, PV) is measured by the sensor and compared with a Setpoint (SP) set by the user.

The purpose of the control block is to reduce the difference between SP and PV (the error signal) to zero by providing a compensating output to the plant via the output driver blocks.

The timer and alarms blocks may be made to operate on a number of parameters within the controller, and digital communications provides an interface to data collection and control.

The way in which each block performs is defined by its internal parameters. Some of these parameters are available to the user so that they can be adjusted to suit the characteristics of the process which is to be controlled.

These parameters are found in lists and the name of each list corresponds with the name of the function block shown in the above diagram.

The above block diagram applies to 3208, 32h8 and 3204 controllers.

For 3216 Output 3 and Logic Input B are not present.

8. Temperature (or Process) Input

Parameters in the input list configure the input to match your sensor. These parameters provide the following features:-

Input Type and linearisation	Thermocouple (TC) and 3-wire resistance thermometer (RTD) temperature detectors Linear input (-10 to +80mV). 0-10V using external voltage divider. mA assumes a 2.49Ω external shunt. See the table in section 0. for the list of input types available
Display units and resolution	The change of display units and resolution will all the parameters related to the process variable
Input filter	First order filter to provide damping of the input signal. This may be necessary to prevent the effects of excessive process noise on the PV input from causing poor control and indication. More typically used with linear process inputs.
Fault detection	Sensor break is indicated by an alarm message 'Sbr'. For thermocouple it detects when the impedance is greater than pre-defined levels; for RTD when the resistance is less than 12Ω.
User calibration	Either by simple offset or by slope and gain. See section 8.2. for further details.
Over/Under range	When the input signal exceeds the input span by more than 5% the PV will flash indicating under or over range. If the value is too high to fit the number of characters on the display 'HHHH' or 'LLLL' will flash. The same indications apply when the display is not able to show the PV, for example, when the input is greater than 999.9°C with one decimal point.

8.1 Process Input Parameters

INPUT LIST		INPUT				
Name	Scrolling Display	Parameter Description	Value		Default	Access Level
IN.TYP	INPUT TYPE	Selects input linearisation and range	See section 8.1.1. for input types available			Conf L3 R/O
UNITS	DISPLAY UNITS	Display units shown on the instrument	nonE	No units - only for custom linearisation	°C	L3
			°C	Celsius		
			°F	Fahrenheit		
			°K	Kelvin		
			PERC	%		
DEC.P	DISPLAY POINTS	Decimal point position	nnnn	No DP	nnnn	Conf L3 R/O
			nnn.n	One DP		
			nn.nn	Two DP		
MV.HI	LINEAR INPUT HIGH	High limit for mV (mA) inputs	-10.00 to +80.00mV		80.00	Conf
MV.LO	LINEAR INPUT LOW	Low limit for mV (mA) inputs	-10.00 to +80.00mV		- 10.00	Conf
RNG.HI	RANGE HIGH LIMIT	Range high limit for thermocouple RTD and mV inputs	From the high limit of the selected input type to the 'Low Range Limit' parameter minus one display unit.			Conf L3 R/O
RNG.LO	RANGE LOW LIMIT	Range low limit for thermocouple RTD and mV inputs	From the low limit of the selected input type to the 'High Range Limit' parameter minus one display unit.			Conf L3 R/O
PV.OFS	PV OFFSET	A simple offset applied to all input values. See section 8.2.	Generally one decimal point more than PV			L3
FILT.T	FILTER TIME	Input filter time	OFF to 100.0 seconds		1.5	L3
CJ.TYP	CJC TYPE	Configuration of the CJC type	Auto	Automatic	Auto	Conf and if T/C L3 R/O
			0°C	Fixed at 0°C		
			50°C	Fixed at 50°C		
SBR.TYP	SENSOR BREAK TYPE	Defines the action which is applied to the control output if the sensor breaks (open circuit). See also section 8.1.2	OFF	No sensor break will be detected	on	Conf L3 R/O
			on	Open circuit sensor will be detected		
			LAR	Latching		
CJ.IN	CJC TEMPERATURE	Temperature measured at the rear terminal block. Used in the CJC calculation	Read only			Conf L3 R/O and if T/C
PV.IN	PV INPUT VALUE	Current measured temperature	Minimum display to maximum display range			Conf L3 R/O

INPUT LIST		INPUT			
Name	Scrolling Display	Parameter Description	Value	Default	Access Level
<i>MV.IN</i>	MILLIVOLT INPUT VALUE	Millivolts measured at the rear PV Input terminals	xx.xx mV - read only		Conf L3 R/O
<i>ROC.FT</i>	ROC FILTER TIME	This provides a first order filter for the rate of change filtering function and can be used to avoid nuisance alarm triggers due to short duration noise on the calculated rate of change.	OFF to 0.1 to 999.9 minutes Off means no filtering applied	16	L3
<i>ROC.PV</i>	PV DERIVATIVE	Provides a measure of the calculated rate of change of the temperature or measurement input as used by the Rate of Change Alarm functions. Useful when commissioning to determine the level of filtering required on the Rate of Change alarm.			L3

8.1.1 Input Types and Ranges

Input Type		Min Range	Max Range	Units	Min Range	Max Range	Units
<i>Jtc</i>	Thermocouple type J	-210	1200	°C	-346	2192	°F
<i>Ktc</i>	Thermocouple type K	-200	1372	°C	-328	2502	°F
<i>Ltc</i>	Thermocouple type L	-200	900	°C	-328	1652	°F
<i>Rtc</i>	Thermocouple type R	-50	1700	°C	-58	3092	°F
<i>Btc</i>	Thermocouple type B	0	1820	°C	32	3308	°F
<i>Ntc</i>	Thermocouple type N	-200	1300	°C	-328	2372	°F
<i>Ttc</i>	Thermocouple type T	-200	400	°C	-328	752	°F
<i>Stc</i>	Thermocouple type S	-50	1768	°C	-58	3215	°F
<i>Rtd</i>	Pt100 resistance thermometer	-200	850	°C	-328	1562	°F
<i>mu</i>	mV or mA linear input	-10.00	80.00				
<i>EmS</i>	Value received over digital communications (modbus address 203). This value must be updated every 5 seconds or the controller will show sensor break						

8.1.2 Operation of Sensor Break

Sensor break type (SB.TYP) can be set to operate in three different modes:-

1. Off
2. On
3. Latching

SB.TYP = Off

Type of Output	Output in Sensor Break	Alarm State
For heat + cool, OP.HI and OP.LO can be set between $\pm 100\%$	OP.HI (100%) Safe value has no effect	No alarm indication will be displayed
For heat only OP.HI and OP.LO can be set between 0.0% and +100%	OP.HI (100%) Safe value has no effect	
For cool only OP.HI and OP.LO can be set between -100.0% and 0%	OP.HI (0%) Safe value has no effect	

SB.TYP = on

Type of Output	Output in Sensor Break	Alarm State
For heat + cool, OP.HI and OP.LO can be set between $\pm 100\%$	'SAFE' value provided it is not set outside the output limits, otherwise it will adopt OP.HI	ALM beacon flashes when an alarm occurs. Output alarm relay activates. ACK has no effect. When the sensor break condition is no longer applicable the alarm indication and output cancel.
For heat only OP.HI and OP.LO can be set between 0.0% and +100%		
For cool only OP.HI and OP.LO can be set between -100.0% and 0%		

SB.TYP = Lat (Alarm latching)

Type of Output	Output in Sensor Break	Alarm State
For heat + cool, OP.HI and OP.LO can be set between $\pm 100\%$	'SAFE' value provided it is not set outside the output limits. i.e. the same as Sbrk = on	ALM beacon flashes when an alarm occurs. Output alarm relay activates. ACK has no effect. When the sensor break condition is no longer applicable it is necessary to press ACK to cancel the alarm.
For heat only OP.HI and OP.LO can be set between 0.0% and +100%		
For cool only OP.HI and OP.LO can be set between -100.0% and 0%		

Note:- When the SAFE output value is outside the OP.LO and OP.HI limits it will be clipped into range and the controller will use the value (i.e. adjusting OP.LO or OP.HI changes the SAFE value so that it is in range).

It could take either the lower or higher OP limit depending on its value and which limit has changed. Therefore, if SAFE = 0 and OP.LO is changed to 10, SAFE will also be set to 10. If SAFE = 50 and OP.HI is changed to 40, SAFE will change to 40.

8.2 PV Offset

All ranges of the controller have been calibrated against traceable reference standards. This means that if the input type is changed it is not necessary to calibrate the controller. There may be occasions, however, when you wish to apply an offset to the standard calibration to take account of known errors within the process, for example, a known sensor error or a known error due to the positioning of the sensor. In these instances it is not advisable to change the reference (factory) calibration, but to apply a user defined offset.

PV Offset applies a single offset to the temperature or process value over the full display range of the controller and can be adjusted in Level 3. It has the effect of moving the curve up a down about a central point as shown in the example below:-

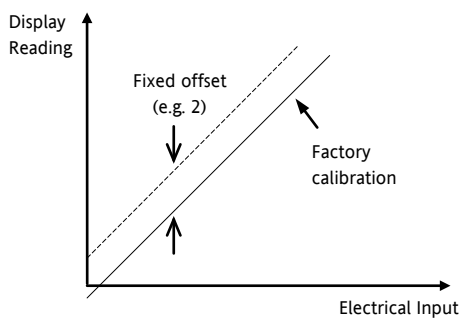

8.2.1 Example: To Apply an Offset:-

Connect the input of the controller to the source device which you wish to calibrate to

Set the source to the desired calibration value

The controller will display the current measurement of the value

If the display is correct, the controller is correctly calibrated and no further action is necessary. If you wish to offset the reading:-

Do This	Display	Additional Notes
1. Select Level 3 or Conf as described in section 6.1.3. Then press to select 'INPUT'		Scrolling display 'PROCESS INPUT LIST'
2. Press to scroll to 'PV/OFS'		Scrolling display 'PV OFFSET'
3. Press or to adjust the offset to the reading you require		In this case an offset of 2.0 units is applied

It is also possible to apply a two point offset which adjusts both low and high points. This is done in Level 3 using the CAL List, and the procedure is described in the Calibration section 16.

8.3 PV Input Scaling

Input scaling applies to the linear mV input range only. This is set by configuring the INPUT TYPE parameter to mV and has an input range of -10 to 80mV. Using an external burden resistor of 2.49Ω, the controller can be made to accept 4-20mA from a current source. Scaling of the input will match the displayed reading to the electrical input levels from the transducer. PV input scaling can only be adjusted in Configuration level and is not provided for direct thermocouple or RTD inputs.

The graph below shows an example of input scaling, where it is required to display 2.0 when the input is 4mV and 500.0 when the input is 20mV .

If the input exceeds +5% of the mV.Lo or mV.Hi settings, sensor break will be displayed.

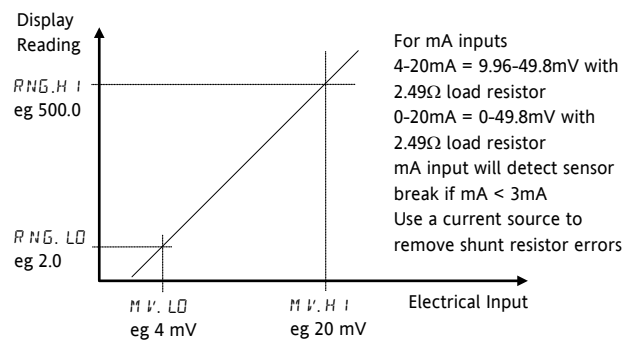

8.3.1 Example: To Scale a Linear Input

Select Configuration level as described in section 6.1.3. Then:-

Do This	Display	Additional Notes
1. Then press to select 'INPUT'		Scrolling display 'PROCESS INPUT LIST'
2. Press to scroll to 'IN.TYP'		Scrolling display 'INPUT TYPE'
3. Press or to 'mV'		
4. Press to scroll to 'MV.HI'		Scrolling display 'LINEAR INPUT HIGH'
5. Press or to '20.00'		
6. Press to scroll to 'MV.LO'		Scrolling display 'LINEAR INPUT LOW'
7. Press or to '4.00'		
8. Press to scroll to 'RHG.HI'		In operator level the controller will read 500.0 for a mV input of 20.00
9. Press or to '500.0'		
10. Press to scroll to 'RNG.LO'		In operator level the controller will read 2.0 for a mV input of 4.00
11. Press or to '2.0'		

9. Input/Output

This section refers to:-

- Digital Inputs
- Current Transformer Input
- Relay/Logic Outputs.

The availability of these is shown in the following table:-

Name	Availability			Output	Input	Output Function	I/O Sense	Beacon (lit when active)	Terminal
	3216	3208 & 32h8	3204						
I/O-1	✓	✓	✓	✓	✓	Heat Cool Alarm Retransmission (setpoint, temperature, output)	Normal Inverted	OP1	1A, 1B
OP-2	✓	✓	✓	✓		Heat Cool Alarm Retransmission (setpoint, temperature, output)	Normal Inverted	OP2	2A, 2B
OP-3		✓	✓	✓		Heat Cool Alarm Retransmission (setpoint, temperature, output)	Normal Inverted	OP3	3A, 3B
OP4 (AA Relay)	✓	✓	✓	✓		Heat Cool Alarm	Normal Inverted	OP4	AA, AB, AC
LA	✓	✓	✓		✓		Normal Inverted		C, LA
LB		✓	✓		✓		Normal Inverted		LB, LC
CT	✓	✓	✓		✓				C, CT
Digital Comms	✓	✓	✓						HD, HE, HF

9.1 Input/Output Parameters

9.1.1 Input/Output 1 List (IO-1)

May be configured as relay, logic or DC output or to accept a digital input from external switch contacts. Connections are made to terminals 1A and 1B. OP1 beacon is operated from the IO-1 channel when it is configured as an output.

INPUT/OUTPUT LIST 1 'IO -1'							
Name	Scrolling Display	Parameter Description	Value		Default	Access Level	
I/O 1	I/O 1 TYPE	I/O channel 1 hardware type defined by the hardware fitted	nonE	No input or output fitted	As ordered	Read only	
			dcOP	DC output - non-isolated (see note 1)			
			REL	Relay output			
			LI	Logic Input/Output			
			SS	Triac output			
I/O 1 FUNCTION	I/O 1 FUNCTION	I/O channel function. If the instrument is ordered as valve positioner (codes VC or VP), only options available are nonE, dcOP, UP, or dn	nonE	Disabled. If disabled no further parameters are shown	HEAT	Conf	
			dcOP	Digital output			
			UP	Valve open codes VC and VP only			
			dn	Valve close codes VC and VP only			
			HEAT	Heat output			
			COOL	Cool output			
			LI	Digital input if 'I/O 1' = 'LI'			
			wSP	Working setpoint re-transmission			Shown if I/O 1 TYPE = dcOP Retransmission
			PU	Process variable re-transmission			
			OP	Output power demand re-transmission			
ISRC.A	I/O 1 SOURCE A	These parameters only appear when the channel function is a Digital output, i.e. I.FUNC = dcOP	nonE	No event connected to the output	nonE	Conf	
ISRC.B	I/O 1 SOURCE B		AL1	Alarm 1			
ISRC.C	I/O 1 SOURCE C		AL2	Alarm 2			
ISRC.D	I/O 1 SOURCE D		AL3	Alarm 3			
I/O 1 DIGITAL INPUT FUNCTION	DIGITAL INPUT FUNCTION	This parameter is only applicable to I/O 1 and only appears if the channel function is a Digital IP i.e. I.FUNC = LI Only one function may be activated by a physical input	AL4	Alarm4	AcAL	Conf	
			ALLA	All alarms			
			nwAL	Any new alarm			
			CTAL	CT alarm, load, leak & overcurrent			
			Lbr	Loop break alarm			
			Sbr	Sensor break alarm			
			tEnd	Timer end status			
			tRun	Timer run status			
			mAn	Manual status			
			rmtF	Remote fail - see section 9.1.2			
			PwrF	Power fail			
			PrGE	Programmer event. See also section 13.2.3			
			nonE	Input not used			
AcAL	Alarm acknowledge						
SP2	Setpoint 2 select						
Lckb	Front keypad disable (keylock)						
tRES	Timer/programmer reset						
tRun	Timer/programmer run						
tRS	Timer/programmer run/reset. Make to run, break to reset						
tHld	Timer/programmer hold						
mAn	Manual status						
Sby	Standby mode. In this mode control outputs go to zero demand						
rmt	Remote digital setpoint select						
rEc	Recipe select through IO1 digital input						
UP	Remote key 'Up'						
dn	Remote key 'Down'						

INPUT/OUTPUT LIST 1 'IO -1'						
Name	Scrolling Display	Parameter Description	Value		Default	Access Level
<i>I.PLS</i>	OUTPUT 1 MINIMUM PULSE TIME	Minimum output on/off time. Only applies to time proportioning outputs and prevents relays from switching too rapidly	<i>0.0</i> to <i>150.0</i>	Auto or 1.0 to 150.0 seconds Auto = 110mS	5.0 sec for relay. Auto for logic	Conf
<i>I.SENS</i>	I/O 1 SENSE	To configure the sense of the input or output channel See also section 9.1.3	<i>nor</i> <i>inv</i>	Normal Inverted	<i>nor</i>	Conf
<i>I.RNG</i>	DC OUTPUT RANGE	To configure 0-20mA or 4- 20mA output Only appears if the output module is DC output	<i>0.20</i>	0-20mA output		L3
			<i>4.20</i>	4-20mA output		

Note 1:-

A DC output may require calibration. This is described in section 16.3.4.

9.1.2 Remote Digital Setpoint Select and Remote Fail

These parameters were added in software version 1.11, and subsequent versions, and are associated with the retransmission of remote setpoint through master comms (see section 15.2.1). 'rmt' allows the remote setpoint to be selected via a digital input and 'rmtF' is a flag which is set if no comms activity is detected for 5 seconds or more when writing to the remote setpoint. The flag is reset when writing to the remote setpoint resumes.

9.1.3 Sense

If the module is an output, 'normal' means a relay output is energised for 100% PID demand. For a heating or cooling output, set this parameter to 'nor'.

'Inverted' means a relay output is energised for 0% PID demand

For an alarm output set this parameter to 'inu' so that it de-energises to the alarm state.

If the module is an input, 'normal' means the function is activated when the input contact is closed, and 'inverted' means the function is activated when the input contact is open.

9.1.4 Source

The four parameters SOURCE A, SOURCE B, SOURCE C, and SOURCE D appear when the output is configured as a digital output i.e. '-FUNC' = 'dOut' and provide the facility to connect up to four alarms or events to operate a single output (normally configured as a relay). If any one of the events becomes true then the output relay will operate.

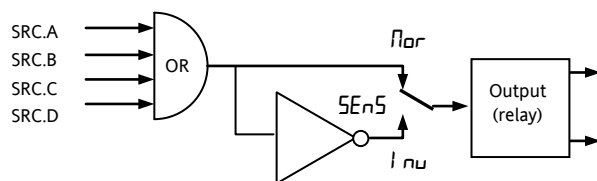

9.1.5 Power Fail

An output, configured as a digital output, can be made to operate following a power fail. It can be acknowledged in the same manner as an alarm but no alarm message is given.

9.1.6 Example: To Configure IO-1 Relay to Operate on Alarms 1 and 2:-

Do This	Display	Additional Notes
1. From any display, press as many times as necessary to select 'IO -1'		Scrolling display 'IO - 1 L I S T'
2. Press to scroll to '1.I D'		This is the identification of the hardware fitted and cannot be adjusted.
3. Press to scroll to '1. F U N C'		The output is configured as a digital output function.
4. Press or to select 'dOut'		Scrolling display 'IO 1 FUNCTION'
5. Press to scroll to '1.SRC.A'		The output will activate if either alarm 1 or alarm 2 occur.
6. Press or to select the event which you want to operate the output, eg 'AL.1'		Scrolling display 'IO 1 SOURCE A'
7. If a second event is required to operate the same output, press to select '1.SRC.B'		Scrolling display 'IO 1 SOURCE B'
8. Press or to select the second event which you want to operate the output, eg 'AL2'		Continue to select up to four events if required using '1SRC.C' and '1SRC.D'
9. Press to scroll to '1.SENS'		'Inverted' means a relay output is energised for 0% PID demand
10. Press or to select 'inu'		'Normal' means a relay output is energised for 100% PID demand Scrolling display 'IO 1 SENSE'

9.1.7 Output List 2 (OP-2)

This is an optional normally open relay or logic output and is available on terminals 2A and 2B. The way in which this output operates is determined by parameters in the OP- 2 List. OP2 beacon is operated from this output channel.

OUTPUT LIST 2 'OP-2'							
Name	Scrolling Display	Parameter Description	Value		Default	Access Level	
2.1 Ⓜ	OUTPUT 2 TYPE	Output channel 2 hardware type	<i>nonE</i>	Output not fitted	As ordered	Read only	
			<i>rELY</i>	Relay output			
			<i>LOP</i>	Logic output (3200 only)			
			<i>dCOP</i>	0-20mA output - non-isolated.			See note 1
			<i>dcrt</i>	0-20mA output - isolated. This parameter appears in 3216 controllers only when an isolated output is fitted (order code C)			
<i>SSr</i>	Triac output						
2FUNC	FUNCTION	Output channel 2 function If the instrument is ordered as valve positioner (codes VC or VP), only options available are <i>nonE</i> , <i>dout</i> , <i>UP</i> , or <i>dwn</i> Note: If output 2 is set to <i>UP</i> ensure the other valve position output is set to <i>dwn</i> and vice versa	<i>nonE</i>	Disabled. If disabled no further parameters are shown	<i>dout</i>	Conf	
			<i>dout</i>	Digital output			
			<i>UP</i>	Valve open codes VC and VP only			
			<i>dwn</i>	Valve close codes VC and VP only			
			<i>HEAT</i>	Heat output			
			<i>COOL</i>	Cool output			
			<i>wSP</i>	Working setpoint re-transmission			Shown if I/O 2 TYPE = <i>dCOP</i> Retransmission
			<i>PU</i>	Process variable re-transmission			
<i>OP</i>	Output power demand re-transmission						
<i>2SRC.A</i>	I/O 2 SOURCE A	These parameters only appear when the channel function is a Digital OP, i.e. 2.FUNC = <i>dout</i> Selects an event status to be connected to the output channel. The output status is the result of an OR of Src A, Src B, Src C, and Src D Up to four events can, therefore, operate the output See section 9.1.4.	<i>nonE</i>	No event connected to the output	<i>nonE</i>	Conf	
<i>2SRC.B</i>	I/O 2 SOURCE B		<i>AL1</i>	Alarm 1 *			
<i>2SRC.C</i>	I/O 2 SOURCE C		<i>AL2</i>	Alarm 2 *			
			<i>AL3</i>	Alarm 3 *			
<i>2SRC.D</i>	I/O 2 SOURCE D		<i>AL4</i>	Alarm4 *			
			<i>ALLA</i>	All alarms			
			<i>nwAL</i>	Any new alarm			
			<i>CTAL</i>	CT alarm, load, leak & overcurrent			
			<i>Lbr</i>	Loop break alarm			
			<i>Sbr</i>	Sensor break alarm			
			<i>EEnd</i>	Timer end status			
			<i>ESun</i>	Timer run status			
<i>mAn</i>	Manual status						
<i>rmEF</i>	Remote fail - see section 9.1.2						
<i>PwrF</i>	Power fail						
<i>PrGE</i>	Programmer event. See also section 13.2.3.						
<i>2PLS</i>	OUTPUT MINIMUM PULSE TIME	Minimum output on/off time. Only applies to time proportioning outputs and prevents relays from switching too rapidly	<i>0.0</i> to <i>150.0</i>	Auto or 1.0 to 150.0 seconds Auto = 110mS	5.0 sec for relay Auto for logic	Conf	
<i>2SENS</i>	SENSE	To configure the polarity of output channel 2 See also section 9.1.3	<i>nor</i>	Normal	<i>nor</i>	Conf	
			<i>inu</i>	Inverted			
<i>2.RNG</i>	DC OUTPUT RANGE	To configure 0-20mA or 4-20mA output Only appears if the output module is DC output	<i>0.20</i>	0-20mA output		L3	
			<i>4.20</i>	4-20mA output			

* The mnemonic for the alarm will change depending upon the alarm configuration.

Note 1:- A DC output may require calibration. This is described in section 16.3.4

9.1.8 Output List 3 (OP-3)

This is an optional normally open relay or 0-20mA isolated dc output and is available on terminals 3A and 3B on 3208 and 3204 only. The way in which this output operates is determined by parameters in the OP- 3 List. OP3 beacon is operated from this output channel.

OUTPUT LIST 3 'OP-3'							
Name	Scrolling Display	Parameter Description	Value		Default	Access Level	
3.I3	OUTPUT 3 TYPE	Output channel 3 hardware type	nonE	Output not fitted	As ordered	Read only	
			RELY	Relay output			
			DCOP	0-20mA output See note 1			
3.FUNC	FUNCTION	Output channel 3 function If the instrument is ordered as valve positioner (codes VC or VP), only options available are , nonE, dout, UP, or dwn Note: If output 3 is set to UP ensure the other valve position output is set to dwn and vice versa	nonE	Disabled. If disabled no further parameters are shown	dout	Conf	
			UP	Valve open codes VC and VP only			
			dwn	Valve close codes VC and VP only			
			HEAT	Heat output			
			COOL	Cool output			
			wSP	Working setpoint re-transmission			Shown if I/O 3 TYPE = DCOP Retransmission
			PU	Process variable re-transmission			
OP	Output re-transmission						
3.SPCA	I/O 3 SOURCE A	These parameters only appear when the channel function is a Digital OP, i.e. 3.FUNC = dout	nonE	No event connected to the output	nonE	Conf	
3.SPCL	I/O 3 SOURCE B		AL1	Alarm 1 *			
	I/O 3 SOURCE C		AL2	Alarm 2 *			
			AL3	Alarm 3 *			
3.SPCL	I/O 3 SOURCE D	Selects an event status to be connected to the output channel. The output status is the result of an OR of Src A, Src B, Src C, and Src D Up to four events can, therefore, operate the output See section 9.1.4.	AL4	Alarm4 *			
			ALLA	All alarms			
			nwAL	Any new alarm			
			CTAL	CT alarm, load, leak & overcurrent			
			Lbr	Loop break alarm			
			Sbr	Sensor break alarm			
			tEnd	Timer end status			
			tRun	Timer run status			
			mAn	Manual status			
			rmEF	Remote fail - see section 9.1.2.			
PwrF	Power fail						
PrGE	Programmer event. See also section 13.2.3.						
3.PLS	OUTPUT MINIMUM PULSE TIME	Minimum output on/off time. Only applies to time proportioning outputs and prevents relays from switching too rapidly	00 to 1500	Auto or 1.0 to 150.0 seconds Auto = 110mS	5.0 sec for relay Auto for logic	Conf	
3.SENS	SENSE	To configure the polarity of output channel 3 See also section 9.1.3.	nor	Normal	nor	Conf	
			inu	Inverted			
3.RNG	DC OUTPUT RANGE	DC output calibration. Only shown if 3.I3 = DCOP	420	4-20mA	420	Conf	
			020	0-20mA			

Note 1:-

A DC output may require calibration. This is described in section 16.3.4

9.1.9 AA Relay (AA) (Output 4)

This is a changeover relay and is optionally available in 3200 controllers. Connections are made to terminals AA, AB, and AC. The way in which this relay operates is determined by parameters in the AA List. OP4 beacon is operated from the AA relay output channel.

AA RELAY 'AA'						
Name	Scrolling Display	Parameter Description	Value		Default	Access Level
4TYPE	OUTPUT 4 TYPE	Output channel 4 hardware type	<i>rELY</i>	Relay output	<i>rELY</i>	Read only
4FUNC	FUNCTION	Output channel 4 function If the instrument is ordered as Valve Position (codes VC or VP), only values <i>nonE</i> , <i>dOUT</i> , <i>uP</i> , or <i>dwn</i> are available Note: If output 4 is set to <i>uP</i> ensure the other valve position output is set to <i>dwn</i> and vice versa	<i>nonE</i>	Disabled	<i>dOUT</i>	Conf
			<i>dOUT</i>	Digital output		
			<i>uP</i>	Valve open codes VC and VP only		
			<i>dwn</i>	Valve close codes VC and VP only		
			<i>HEAT</i>	Heat output		
			<i>COOL</i>	Cool output		
4SRC.A	I/O 4 SOURCE A	These parameters only appear when the channel function is a Digital OP, i.e. 4.FUNC = <i>dOUT</i> Selects an event status to be connected to the output channel. The output status is the result of an OR of Src A, Src B, Src C, and Src D Up to four events can, therefore, operate the output See section 9.1.4.	<i>nonE</i>	No event connected to the output	<i>nonE</i>	Conf
4SRC.B	I/O 4 SOURCE B		<i>AL1</i>	Alarm 1 *		
			<i>AL2</i>	Alarm 2 *		
			<i>AL3</i>	Alarm 3 *		
			<i>AL4</i>	Alarm 4 *		
4SRC.C	I/O 4 SOURCE C		<i>ALLA</i>	All alarms		
			<i>nwAL</i>	Any new alarm		
4SRC.D	I/O 4 SOURCE D		<i>CTAL</i>	CT alarm, load, leak & overcurrent		
			<i>Lbr</i>	Loop break alarm		
			<i>Sbr</i>	Sensor break alarm		
			<i>tEnd</i>	Timer end status		
			<i>tRun</i>	Timer run status		
			<i>mAn</i>	Manual status		
			<i>rmEF</i>	Remote fail - see section 9.1.2.		
			<i>PwrF</i>	Power fail		
			<i>PrGE</i>	Programmer event. See also section 13.2.3.		
4PLS	OUTPUT MINIMUM PULSE TIME	Minimum output on/off time. Only applies to time proportioning outputs and prevents relays from switching too rapidly	<i>00</i> to <i>1500</i>	0 to 150 seconds	5.0 sec	Conf
4SENS	SENSE	To configure the polarity of output channel 4 See also section 9.1.3.	<i>nor</i>	Normal	<i>nor</i>	Conf
			<i>inu</i>	Inverted		

* The mnemonic for the alarm will change depending upon the alarm configuration.

9.1.10 Digital Input Parameters

Digital Input A. This is an optional input wired to terminals C and LA. The input is typically from a voltage free contact, which can be configured to operate a number of functions as determined by parameters in the LA List.

☺ 3216 controllers can be fitted with optional EIA232 digital communications. In this case the digital input is not available.

Note: Terminal C is common to the CT input and is, therefore, not isolated from the CT.

Digital Input B. This is wired to terminals LB and LC and is available in 3208 and 3204 controllers only.

The parameter lists are identical as shown below:-

LOGIC INPUT LIST 'LA' / 'LB'						
Name	Scrolling Display	Parameter Description	Value		Default	Access Level
LTYPE	LOGIC INPUT TYPE	Input channel type	LJP	Logic input	As order code	Conf Read only
L.IN	LOGIC INPUT FUNCTION	To configure the function of the digital input	nonE	Input not used	ACAL	Conf
			ACAL	Alarm acknowledge		
			SP2	Setpoint 2 select		
			Loc.b	Front keypad disable		
			TERES	Timer/programmer reset		
			TERUN	Timer/programmer run		
			TERS	Timer/programmer run/reset. Make to run, break to reset		
			THLD	Timer/programmer hold		
			mAn	Manual status		
			Sby	Standby mode. In this mode control outputs go to zero demand		
			rmE	To allow a remote setpoint to be selected through the LA digital input. See section 9.1.2		
			rEc	Recipe select through IO1 digital input		
			UP	Remote key 'Up'		
			dwn	Remote key 'Down'		
L.SENS	LOGIC INPUT SENSE	To configure the polarity of the input channel	nor	Normal	nor	Conf
			inu	Inverted		
			420	4-20mA output		

9.2 Current Transformer Input Parameters

This is optional on 3200 controllers and can measure, via an external current transformer, the current flowing through the electrical load when the heat output is 'on' (load current) and also when it is 'off' (leakage current).

☺ 3216 controllers can be fitted with optional EIA232 digital communications. In this case the current transformer input is not available.

Alarm If the load current is lower than a threshold limit or the leakage current is higher than a threshold limit, then an alarm triggers. The hysteresis to exit from either of these alarm conditions is fixed at 2% of the current transformer span.

Full scale value Selectable from 10 to 1000A

CURRENT TRANSFORMER LIST 'CT - INP'						
Name	Scrolling Display	Parameter Description	Value		Default	Access Level
CTID	MODULE TYPE	CT module identity	CTn	CT input circuit fitted	As order code	Conf read only
CTSRC	CT SOURCE	Selects the output controlling the current measured by the CT input. The source can only be selected if the output has been configured for Heat or Cool	none	None		
			IO-1	Input/output 1		
			OP-2	Output 2		
			RR	AA Relay		
CTRNG	CT RANGE	Sets the CT inputs range	0 to CT full scale value (1000)		As order code	Conf
CTLRT	CT ALARM LATCH TYPE	To configure the latch mode of the CT input alarm. A description of alarm latching is given in the alarm section	none	No latching	no	Conf if CT alarm enabled
			Auto	Latched with automatic reset		
			man	Latched with manual reset		
LDALM	LOAD CURRENT THRESHOLD	Load open circuit alarm threshold – low alarm	OFF to CT full scale value (settable to 3000)			Read only
LHALM	LEAK CURRENT THRESHOLD	Leakage current in the off state alarm threshold – high alarm	OFF to CT full scale value (settable to 3000)			Read only
HCALM	OVER CURRENT THRESHOLD	Overcurrent threshold – high alarm	OFF to CT full scale value (settable to 3000)			
LDAMP	LOAD CURRENT	Measured load current				L3 if CT input enabled
LHALM	LEAK CURRENT	CT input leakage current				L3 if CT input enabled
CTMTR	CT METER RANGE	To set the range of the meter. 3208 and 3204 only.	0 to 1000			L3

9.2.1 Analogue Representation of Current Alarms

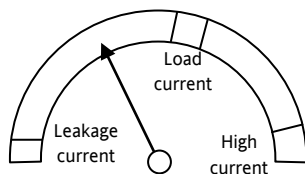

The meter is available in 3208 and 3204 controllers only.

10. Setpoint Generator

The setpoint generator provides the target value at which it is required to control the process. It is shown in the controller block diagram, Section 7. The following functions are available:-

Number of setpoints Two - setpoint 1 (SP1) and setpoint 2 (SP2).

Each may be selected by a dedicated parameter or externally switched via a digital input suitably configured as described in section 9.1.10.

An application example might be to use SP1 for normal operation and SP2 to maintain a low overnight temperature.











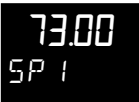

Setpoint limits	High and low limits can be pre-set to prevent inadvertent adjustment of the setpoint beyond that allowable for the process
Set point rate limit	Allows the setpoint to change from its current level to a new level at a fixed rate.
Direct setpoint access	The selected setpoint is accessible directly from the HOME display by pressing the raise or lower buttons

10.1 Setpoint Parameters

SETPOINT LIST 'SP'						
Name	Scrolling Display	Parameter Description	Value		Default	Access Level
SP.SEL	SETPOINT SELECT	This enables the main or secondary setpoint to be selected from the front panel buttons	SP1	Setpoint 1 selected	SP1	L3
			SP2	Setpoint 2 selected		
SP1	SETPOINT 1	Main or normally selected setpoint	Low to high setpoint limits		0	L3
SP2	SETPOINT 2	Secondary or standby setpoint	Low to high setpoint limits		0	L3
SP.HI	SETPOINT HIGH LIMIT	Maximum allowable setpoint setting	Setpoint low limit (SP.LO) to high range limit. Also limited by the RNG.HI and RNG.LO parameters		Range High Limit	L3
SP.LO	SETPOINT LOW LIMIT	Minimum allowable setpoint setting	Low range limit to Setpoint high limit (SP.HI). Also limited by the RNG.HI and RNG.LO parameters		Range Low Limit	L3
REM.SP	REMOTE SETPOINT	Reads the current remote setpoint value when remote setpoint is in use				Read only
L-R	REMOTE SETPOINT SELECT	To select the remote digital communications setpoint	NO	Not selected	no	Conf
			YES	Selected		
SP.RAT	SETPOINT RATE LIMIT	Limits the rate of change of the setpoint. Operates on both SP1 and SP2	Step change (OFF) or 0.1 to 3000 display units per minute. Resolution one decimal place more than PV		OFF	L3
RAMP.U	SETPOINT RAMP UNITS	To set the units for the setpoint rate limit	min	Minutes	min	L3
			Hour	Hours		
			SEC	Seconds		
LOC.T	LOCAL SETPOINT TRIM	Local trim on remote setpoint. Applies a fixed offset to the remote setpoint	-199.9 to 300.0		00	L3
REM.HI	REMOTE INPUT HIGH SCALAR	Sets the maximum scale limit for the remote setpoint	Between Setpoint High and Low Limits up to firmware version 2.11. From 2.11 the values can be varied within the entire instrument range. This allows, for example, a 0-5V device to be used with a 0-10V input such that the 5V can correspond to the full setpoint range.			L3
REM.LO	REMOTE INPUT LOW SCALAR	Sets the minimum scale limit for the remote setpoint				
ROP.HI	SETPOINT RETRANS HIGH	Sets the upper limit for the setpoint retransmission	These two parameters have been added from firmware version 2.11.			L3
ROP.LO	SETPOINT RETRANS LOW	Sets the lower limit for the setpoint retransmission	They replace Setpoint High and Low Limits as the outer limits for a retransmitted setpoint. In versions prior to 2.11 the transmitted setpoint is scaled against its full range. Setpoint Retrans High & Low allow the retransmitted setpoint to be scaled against a sub-range. The values correspond to the setpoint transmitted at 4 and 20mA – if the setpoint is outside this range then it is clipped.			L3

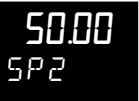
10.2 Example: To Set Ramp Rate

This is available in Level 3.

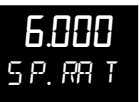
Do This	The Display You Should See	Additional Notes
1. Press  as many times as necessary to select 'SETPOINT LIST'		
2. Press  as many times as necessary to scroll to 'SP1' 3. Press  or  to adjust setpoint 1		This step can be repeated for the lower setpoint limit 'SP.LD'
4. Press  to scroll to 'SP2' 5. Press  or  to adjust setpoint 2		
6. Press  as many times as necessary to scroll to 'SP.RAT' 7. Press  or  to set the rate at which you require the setpoint to change		Whenever the setpoint is changed, the controller will ramp from its current setpoint to the new value at the rate set in units per second, minute or hours as set by the 'RAMPU' parameter. It will also change at the same rate when switching between SP2 and SP1 (but not between SP1 and SP2) The setpoint rate resolution is generally one decimal point more than setpoint/PV resolution

11. Control

Parameters in this section allow the control loop to be set up for optimum control conditions. An example of a temperature control loop is shown below:-

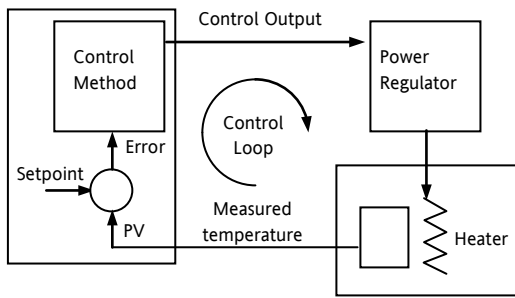

The actual temperature measured at the process (PV) is connected to the input of the controller. This is compared with a setpoint (or required) temperature (SP). If there is an error between the set and measured temperature the controller calculates an output value to call for heating or cooling. The calculation depends on the process being controlled but normally uses a PID algorithm. The output(s) from the controller are connected to devices on the plant which cause the heating (or cooling) demand to be adjusted which in turn is detected by the temperature sensor. This is referred to as the control loop or closed loop control.

11.1 Types of Control

Three types of control loop may be configured. These are On/Off control, PID control or control of motorised valves

11.1.1 On/Off Control

On/Off control is the simplest means of control and simply turns heating power on when the PV is below setpoint and off when it is above setpoint. As a consequence, On/Off control leads to oscillation of the process variable. This oscillation can affect the quality of the final product and may be used on non-critical processes. A degree of hysteresis must be set in On/Off control if the operation of the switching device is to be reduced and relay chatter is to be avoided.

If cooling is used, cooling power is turned on when the PV is above setpoint and off when it is below.

It is suitable for controlling switching devices such as relays, contactors, triacs or digital (logic) devices.

11.1.2 PID Control

PID, also referred to as 'Three Term Control', is an algorithm which continuously adjusts the output, according to a set of rules, to compensate for changes in the process variable. It provides more stable control but the parameters need to be set up to match the characteristics of the process under control.

The three terms are:

Proportional band PB

Integral time TI

Derivative time TD

The output from the controller is the sum of the contributions from these three terms. The combined output is a function of the magnitude and duration of the error signal, and the rate of change of the process value.

It is possible to turn off integral and derivative terms and control on proportional only (P), proportional plus integral (PI) or proportional plus derivative (PD).

PI control might be used, for example, when the sensor measuring an oven temperature is susceptible to noise or other electrical interference where derivative action could cause the heater power to fluctuate wildly.

PD control may be used, for example, on servo mechanisms.

In addition to the three terms described above, there are other parameters which determine how well the control loop performs. These include Cutback terms, Relative Cool Gain, Manual Reset and are described in detail in subsequent sections.

11.1.3 Motorised Valve Control

This algorithm is designed specifically for positioning motorised valves. It operates in boundless mode (sometimes called unbounded) which does not require a position feedback potentiometer to operate. It is a velocity mode algorithm which directly controls the direction and velocity of the movement of the valve in order to minimise the error between the setpoint and the PV. It uses triac or relay outputs to drive the valve motor.

11.1.3.1 Motorised Valve Control in Manual mode

When manual is selected the algorithm predicts where the valve will move to based on the edit of the manual power. Effectively, when the raise or lower key is pressed, +100% or -100% velocity is used for the duration of the key press and the raise or lower output is turned on. In boundless mode it is essential that the Motor Travel Time, 'MTR.T' is set correctly in order for the integral time to calculate correctly. Motor travel time is defined as **valve** fully open – **valve** fully closed - it is not necessarily the time printed on the motor since, if mechanical stops have been set on the motor, the travel time of the actual valve may be different. Also, if the travel time for the valve is set correctly, the position indicated on the controller will fairly accurately match the actual valve position.

Every time the valve is driven to its end stops the algorithm is reset to 0% or 100% to compensate for any changes which may occur due to wear in linkages or other mechanical parts.

11.2 Control Parameters

The control loop is configured by the parameters listed in the following table:-

CONTROL LIST 'CTRL'					
Parameter Name	Parameter Description (Scrolling Display)	Value		Default	Access Level
CTRL.H	HEATING TYPE Selects the channel 1 control algorithm. Different algorithms may be selected for channels 1 and 2. In temperature control applications, Ch1 is usually the heating channel, Ch2 is the cooling channel.	PID	PID	As order code	Conf
		OFF	Heating off		
		onOFF	On/Off		
		mtc	Valve position control		
CTRL.C	COOLING TYPE Selects the channel 2 Control algorithm. Different algorithms may be selected for channels 1 and 2. This is not available if the instrument is a valve position controller	OFF	Cooling disable	As order code	Conf
		PID	PID		
		onOFF	On/Off		
CTRL.A	CONTROL ACTION Selects the direction of the control. i.e reverse or direct acting.	REV	Reverse acting. Output decreases as PV increases	REV	Conf
		DIR	Direct acting. Output increases as PV decreases		
PB.UNIT	PROPORTIONAL BAND UNITS	ENG	In engineering units		
		PERC	In percent		
RTUNE	AUTO-TUNE ENABLE	OFF	Auto-tune off	OFF	L3
		On	Set to 'on' to start auto-tuning		
		FAIL	Displayed if Autotune cannot be completed		
RT.R2G	AUTOTUNE CONFIGURES R2G See section 11.4 for an explanation.	YES	R2G will be set by Auto-tune	YES	Conf
		No	Allows a value for R2G to be entered manually		
PB	PROPORTIONAL BAND See also section 11.2.1	0.1 to 9999 display units or 1 to 999.9% if proportional band expressed as %		20	L3
TI	INTEGRAL TIME See also section 11.2.2	OFF to 9999 seconds		360 sec	L3
TD	DERIVATIVE TIME See also section 11.2.3	OFF to 9999 seconds TD defaults to OFF for valve position control		60 sec	L3
R2G	RELATIVE COOL GAIN See also section 11.2.4	0.1 to 10.0		1.0	L3
CB.H	CUTBACK HIGH See also section 11.2.5	Auto or 1 to 3000 display units		Auto = 3xPb	L3
CB.L	CUTBACK LOW See also section 11.2.5	Auto or 1 to 3000 display units		Auto = 3XPb	L3
MR	MANUAL RESET	0.0 to 100.0% (heat only) -100.0 to 100.0% (heat/cool)		0.0%	L3
LBT	LOOP BREAK TIME The loop break alarm attempts to detect loss of restoring action in the control loop by checking the control output, the process value and its rate of change. Loop break detection works for all control algorithms: PID, VP and ON-OFF. Note: This is not to be confused with load failure and partial load failure.	OFF	Setting loop Break Time to OFF disables the Loop Break Alarm	OFF	L3
		1 to 9999 minutes			

CONTROL LIST					
Parameter Name	Parameter Description (Scrolling Display)	Value		Default	Access Level
OP.HI	OUTPUT HIGH Adjust to limit the maximum heating power applied to the process	±100.0%		100.0%	L3
OP.LO	OUTPUT LOW Adjust to limit the maximum cooling power applied to the process or to apply a minimum heating power	±100.0%		0.0 (heat only) -100 (cool)	L3
MTR.T	MOTOR TRAVEL TIME Set this value to the time that it takes for the motor to travel from its fully closed to its fully open position.	00 to 999.9 seconds Note: In motorised valve control only the PB and TI parameters are active. The TD parameter has no effect on the control.		0.0	L3
DBAND	CHANNEL 2 DEAD BAND Period when no output is demanded from either channel 1 or channel 2 Adjust, for example, to increase the period when no heating or cooling power is applied	OFF or 0.1 to 100.0% of the cooling proportional band		OFF	L3
HYS.T.H	HEATING HYSTERESIS	1 to 9999 display units		1	L3
HYS.T.C	COOLING HYSTERESIS			1	On/off only
SAFE	SAFE OUTPUT POWER To set the output level in a sensor break (open circuit) condition	-100.0 to 100.0% limited by OP.HI and OP.LO		0.0%	L3
F.MOD	FORCED MANUAL OUTPUT MODE Selects how the loop behaves on transfer from Auto to Manual. Transfer from Manual to Auto is always bumpless.	nonE	Transfer between Auto/Manual/Auto is bumpless	nonE	L3
		STEP	Transfer from Auto to Manual, the output goes to a pre-set value (F.OP)		
		LAST	Transfer from Auto to Manual, the output goes to the previously set manual value		
COOL.T	NON-LINEAR COOLING TYPE This selects an algorithm most suited to the type of cooling. Typically used in extruders.	Lin	Linear	As order code	Conf
		Oil	Oil cooling		
		H2O	Water cooling		
		FAn	Forced air cooling		
F.OP	FORCED OUTPUT To pre-set a value for the Manual output when F.MOD = STEP	-100.0 to 100.0% limited by OP.HI and OP.LO		0.0	L3
R-M	LOOP MODE – AUTO MANUAL OFF see also section 4.4.4.	Auto	To select automatic operation		L3
		man	To select manual operation		
		OFF	Control outputs inhibited		
LBR	LOOP BREAK STATUS	No	Shows the current status of loop break.		Read only
		YES			
TU.HI	TUNE HIGH LIMIT. Set this to limit the maximum heating output during autotune	Range between OP.HI and OP.LO			L3
TU.LO	TUNE LOW LIMIT. Set this to limit the maximum cooling output during autotune				

Parameters are further described in the following sections.

11.2.1 Proportional Band 'PB'

The proportional band, or gain, delivers an output which is proportional to the size of the error signal. It is the range over which the output power is continuously adjustable in a linear fashion from 0% to 100% (for a heat only controller). Below the proportional band the output is full on (100%), above the proportional band the output is full off (0%) as shown in the diagram below.

The width of the proportional band determines the magnitude of the response to the error. If it too narrow (high gain) the system oscillates by being over responsive. If it is too wide (low gain) the control is sluggish. The ideal situation is when the proportional band is as narrow as possible without causing oscillation.

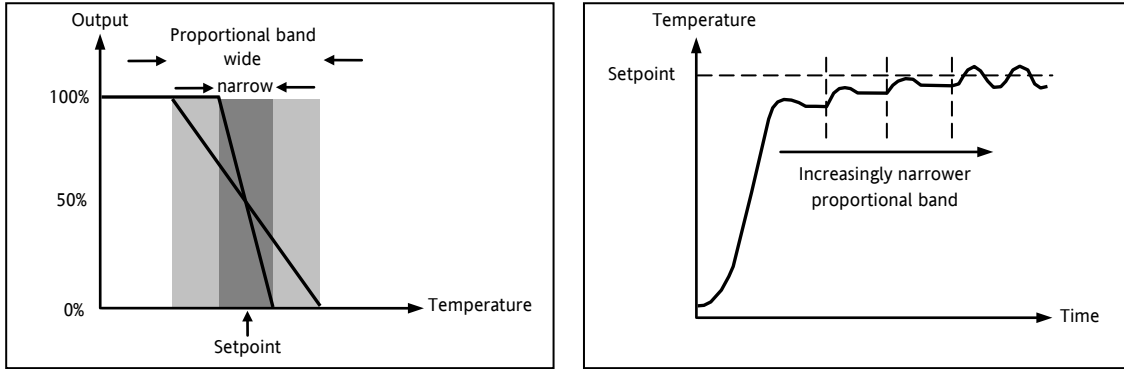

The diagram also shows the effect of narrowing proportional band to the point of oscillation. A wide proportional band results in straight line control but with an appreciable initial error between setpoint and actual temperature. As the band is narrowed the temperature gets closer to setpoint until finally becoming unstable.

The proportional band may be set in engineering units or as a percentage of the controller range.

11.2.2 Integral Term 'TI'

In a proportional only controller, an error between setpoint and PV must exist for the controller to deliver power. Integral is used to achieve **zero** steady state control error.

The integral term slowly shifts the output level as a result of an error between setpoint and measured value. If the measured value is below setpoint the integral action gradually increases the output in an attempt to correct the error. If it is above setpoint integral action gradually decreases the output or increases the cooling power to correct the error.

The diagram below shows the result of introducing integral action.

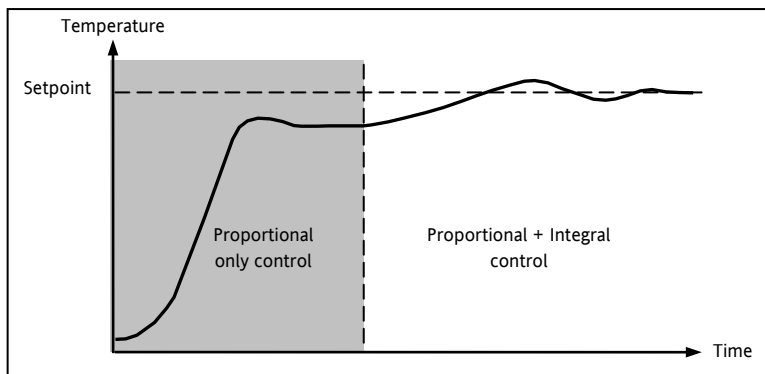

The units for the integral term are measured in time (1 to 9999 seconds in 3200 controllers). The longer the integral time constant, the more slowly the output is shifted and results in a sluggish response. Too small an integral time will cause the process to overshoot and even oscillate. The integral action may be disabled by setting its value to Off.

11.2.3 Derivative Term 'TD'

Derivative action, or rate, provides a sudden shift in output as a result of a rapid change in error. If the measured value falls quickly derivative provides a large change in output in an attempt to correct the perturbation before it goes too far. It is most beneficial in recovering from small perturbations.

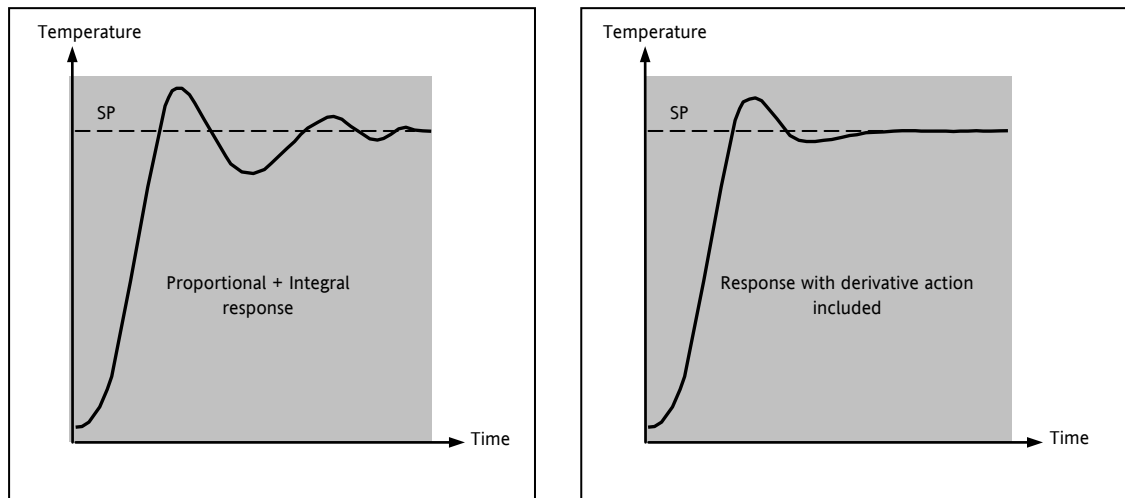

The derivative modifies the output to reduce the rate of change of error. It reacts to changes in the PV by changing the output to remove the transient. Increasing the derivative time will reduce the settling time of the loop after a transient change.

Derivative is often mistakenly associated with overshoot inhibition rather than transient response. In fact, derivative should not be used to curb overshoot on start up since this will inevitably degrade the steady state performance of the system. Overshoot inhibition is best left to the approach control parameters, High and Low Cutback, section 11.2.5.

Derivative is generally used to increase the stability of the loop, however, there are situations where derivative may be the cause of instability. For example, if the PV is noisy, then derivative can amplify that noise and cause excessive output changes, in these situations it is often better to disable the derivative and re-tune the loop.

If set to Off(0), no derivative action will be applied.

In 3200 controllers derivative is calculated on change of PV. For applications such as furnace temperature control, it is common practice to use Derivative on PV to prevent thermal shock caused by a sudden change of output as a result of a change in setpoint.

11.2.4 Relative Cool Gain 'R2G'

The proportional band parameter 'PB' adjusts the proportional band for the heating output. Relative cool gain adjusts the cooling proportional band relative to the heating proportional band. If the rate of heating and rate of cooling are widely different it may be necessary to manually adjust Relative Cool Gain to achieve the optimum settings for the cooling proportional band. A nominal setting of around 4 is often used.

Note, This parameter is set automatically when Auto-tune is used unless the parameter 'AT.R2G' is set to 'No' - see section 11.4.

11.2.5 High and Low Cutback

Cutback high 'CBHI' and Cutback low 'CBLO' are values that modify the amount of overshoot, or undershoot, that occurs during large step changes in PV (for example, under start-up conditions). They are independent of the PID terms which means that the PID terms can be set for optimal steady state response and the cutback parameters used to modify any overshoot which may be present.

Cutback involves moving the proportional band towards the cutback point nearest the measured value whenever the latter is outside the proportional band and the power is saturated (at 0 or 100% for a heat only controller). The proportional band moves downscale to the lower cutback point and waits for the measured value to enter it. It then escorts the measured value with full PID control to the setpoint. In some cases it can cause a 'dip' in the measured value as it approaches setpoint, as shown in the diagram below, but generally decreases the time needed to bring the process into operation.

The action described above is reversed for falling temperature.

If cutback is set to Auto the cutback values are automatically configured to 3*PB.

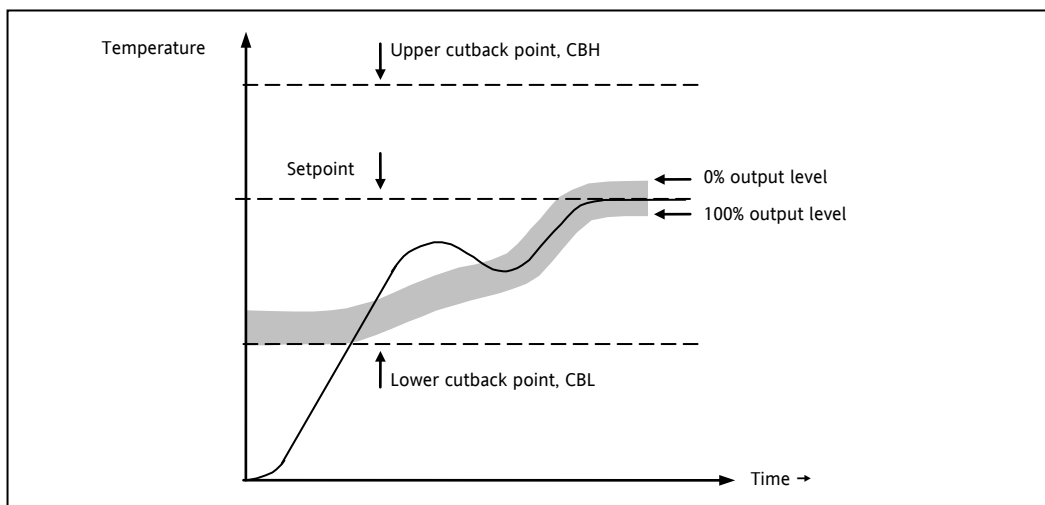

11.2.6 Manual Reset

In a full three-term controller (that is, a PID controller), the integral term automatically removes the steady state error from the setpoint. If the controller is set as a PD controller, the integral term will be set to 'OFF'. Under these conditions the measured value may not settle precisely at setpoint. The Manual Reset parameter (MR) represents the value of the power output that will be delivered when the error is zero. You must set this value manually in order to remove the steady state error.

11.2.7 Control Action

When set to reverse (*REV*) the output increases when the PV is below setpoint. This is the best setting for heating control.

For cooling control only set Control Action to direct (*DIR*).

11.2.8 Loop Break

The loop is considered to be broken if the PV does not respond to a change in the output. Since the time of response will vary from process to process the **Loop Break Time** parameter allows a time to be set before a **Loop Break Alarm** is initiated. In these circumstances the output power will drive to high or low limit. For a PID controller, if the PV has not moved by $0.5 \times P_b$ in the loop break time the loop is considered to be in break. The loop break time is set by the Auto-tune, a typical value is $12 \times T_d$. For an On/Off controller Loop Break Time is not shown and loop break alarm is inhibited.

11.2.9 Cooling Algorithm

The method of cooling may vary from application to application.

For example, an extruder barrel may be cooled by forced air (from a fan), or by circulating water or oil around a jacket. The cooling effect will be different depending on the method. The cooling algorithm may be set to linear where the controller output changes linearly with the PID demand signal, or it may be set to water, oil or fan where the output changes non-linearly against the PID demand. The algorithm provides optimum performance for these methods of cooling.

11.3 Tuning

In tuning, you match the characteristics (PID parameters) of the controller to those of the process being controlled in order to obtain good control. Good control means:

- Stable, 'straight-line' control of the PV at setpoint without fluctuation
- No overshoot, or undershoot, of the PV setpoint
- Quick response to deviations from the setpoint caused by external disturbances, thereby rapidly restoring the PV to the setpoint value.

Tuning involves setting the following parameters:-

Proportional Band 'PB', Integral Time 'TI', Derivative Time 'TD', Cutback High 'CBHI', Cutback Low 'CBLO', and Relative Cool Gain 'R2G' (applicable to heat/cool systems only).

The controller is shipped with these parameters set to default values. In many cases the default values will give adequate stable straight line control, however, the response of the loop may not be ideal. Because the process characteristics are fixed by the design of the process it is necessary to adjust the control parameters in the controller to achieve best control. To determine the optimum values for any particular loop or process it is necessary to carry out a procedure called loop tuning. If significant changes are later made to the process which affect the way in which it responds it may be necessary to retune the loop.

Users have the choice of tuning the loop automatically or manually. Both procedures require the loop to oscillate and both are described in the following sections.

11.3.1 Loop Response

If we ignore the situation of loop oscillation, there are three categories of loop performance:

Under Damped - In this situation the terms are set to prevent oscillation but do lead to an overshoot of the Process Value followed by decaying oscillation to finally settle at the Setpoint. This type of response can give a minimum time to Setpoint but overshoot may cause problems in certain situations and the loop may be sensitive to sudden changes in Process Value. This will result in further decaying oscillations before settling once again.

Critically Damped - This represents an ideal situation where overshoot to small step changes does not occur and the process responds to changes in a controlled, non oscillatory manner.

Over Damped - In this situation the loop responds in a controlled but sluggish manner which will result in a loop performance which is non ideal and unnecessarily slow.

The balancing of the P, I and D terms depends totally upon the nature of the process to be controlled.

In a plastics extruder, for example, a barrel zone will have a different response to a die, casting roll, drive loop, thickness control loop or pressure loop. In order to achieve the best performance from an extrusion line all loop tuning parameters must be set to their optimum values.

11.3.2 Initial Settings

In addition to the tuning parameters listed in section 11.3 above, there are a number of other parameters which can have an effect on the way in which the loop responds. Ensure that these are set before either manual or automatic tuning is initiated. Parameters include, but are not limited to:-

Setpoint. Set this as closely as practicable to the actual setpoint in normal operation.

Load Conditions. Set the load conditions as closely as possible to those which will be met in practice. For example, in a furnace or oven application a representative load should be included, an extruder should be running, etc.

Heat/Cool Limits. The minimum and maximum power delivered to the process may be limited by the parameters 'OUTPUT LOW' and 'OUTPUT HIGH' both of which are found in the Control list. For a heat only controller the default values are 0 and 100%. For a heat/cool controller the defaults are -100 and 100%. Although it is expected that most processes will be designed to work between these limits there may be instances where it is desirable to limit the power delivered to the process. For example, if driving a 220V heater from a 240V source the heat limit may be set 80% to ensure that the heater does not dissipate more than its maximum power.

☺ The measured value *must* oscillate to some degree for the tuner to be able to calculate values. The limits must be set to allow oscillation about the setpoint.

Channel 2 Deadband. In controllers fitted with a second (cool) channel a parameter 'D.BAND' is also available in the Control list, which sets the distance between the heat and cool proportional bands. The default value is 0% which means that heating will turn off at the same time as cooling turns on. The deadband may be set to ensure that there is no possibility of the heat and cool channels being on together, particularly when cycling output stages are installed.

Minimum Pulse Time. If either or both of the output channels is fitted with a relay, triac or logic output, the parameter '-.PLS' will appear in the relevant output list (IO-1 list, OP-2 list, OP-3 list or AA Relay Output list). This is the cycling time for a time proportioning output and should be set correctly before tuning is started.

Input Filter Time Constant. The parameter 'FILTER TIME' should be set before tuning the loop. It is found in the INPUT List.

Valve Travel Time. If the output is a motor valve positioner the parameter 'MTR.T' (Control List) should be set to the time that it takes for the motor to travel from its fully closed to its fully open position.

Other Considerations

- If a process includes adjacent interactive zones, each zone should be tuned independently.
- It is always better to start a tune when the PV and setpoint are far apart. This allows start up conditions to be measured and cutback values to be calculated more accurately.
- In a programmer/controller tuning should only be attempted during dwell periods and not during ramp stages. If a programmer/controller is tuned automatically put the controller into Hold during each dwell period whilst autotune is active. It may be worth noting that tuning, carried out in dwell periods which are at different extremes of temperature may give different results owing to non linearity of heating (or cooling).

11.3.3 Automatic Tuning

Auto Tune automatically sets the following parameters:-

Proportional Band ' PB '	
Integral Time ' Ti '	If ' Ti ' and/or ' Td ' is set to OFF, because you wish to use PI, PD or P only control, these terms will remain off after an autotune.
Derivative Time ' Td '	
Cutback High ' CBHI '	If CBH and/or CBL is set to ' Auto ' these terms will remain at Auto after an autotune, i.e. 3*PB. For autotune to set the cutback values, CBHI and CBLO must be set to a value (other than Auto) before autotune is started. Autotune will never return cutback values which are less than 1.6*PB.
Cutback Low ' CBLO '	
Relative Cool Gain ' R2G '	R2G is only calculated if the controller is configured as heat/cool. Following an autotune, ' R2G ' is always limited to between 0.1 and 10. If the calculated value is outside this limit a 'Tune Fail' alarm is given.
Loop Break Time ' LBT '	Following an autotune, ' LBT ' is set to 2*Ti (assuming the integral time is not set to OFF). If ' Ti ' is set to OFF then ' LBT ' is set to 12*Td.

Auto tune uses the 'one-shot' tuner which works by switching the output on and off to induce an oscillation in the process value. From the amplitude and period of the oscillation, it calculates the tuning parameter values. The autotune sequence for different conditions is described in sections 11.3.5 to 0.

11.3.4 To Start Autotune

In operator levels 2 or 3, set the 'AUTO-TUNE ENABLE' parameter to 'On'.

Press the Page and Scroll buttons together to return to the Home display. The display will flash '**E_{un}E**' to indicate that tuning is in progress.

A One-shot Tune can be performed at any time, but normally it is performed only once during the initial commissioning of the process. However, if the process under control subsequently becomes unstable (because its characteristics have changed), it may be necessary to tune again for the new conditions.

The auto tune algorithm reacts in different ways depending on the initial conditions of the plant. The explanations given in this section are for the following conditions:-

1. Initial PV is below the setpoint and, therefore, approaches the setpoint from below for a heat/cool control loop
 2. Initial PV is below the setpoint and, therefore, approaches the setpoint from below for a heat only control loop
 3. Initial PV is at the same value as the setpoint. That is, within 0.3% of the range of the controller if '**PB.UNT**' is set to '**percent**' or ± 1 engineering unit (1 in 1000) if the '**PB.UNT**' is set to '**Eng**'. Range is defined as 'Range High Limit' to 'Range Low Limit' for process inputs or the range defined in section 8.1 for temperature inputs.
- ☺ If the PV is just outside the range stated above the autotune will attempt a tune from above or below SP.
 - ☺ If the controller is autotuning and sensor break occurs, the autotune will abort. Autotune must be re-started when the sensor break condition is no longer present.
 - ☺ If an Autotune cannot be performed an error message, **E_{un}**, will be flashed in the display

11.3.5 Autotune from Below SP – Heat/Cool

The point at which Automatic tuning is performed (Tune Control Point) is designed to operate just below the setpoint at which the process is normally expected to operate (Target Setpoint). This is to ensure that the process is not significantly overheated or overcooled. The Tune Control Point is calculated as follows:-

$$\text{Tune Control Point} = \text{Initial PV} + 0.75(\text{Target Setpoint} - \text{Initial PV}).$$

The Initial PV is the PV measured at 'B' (after a 1 minute settling period)

Examples: If Target Setpoint = 500°C and Initial PV = 20°C, then the Tune Control Point will be 380°C.

If Target Setpoint = 500°C and Initial PV = 400°C, then the Tune Control Point will be 475°C.

This is because the overshoot is likely to be less as the process temperature is already getting close to the target setpoint.

The sequence of operation for a tune from below setpoint for a heat/cool control loop is described below:-

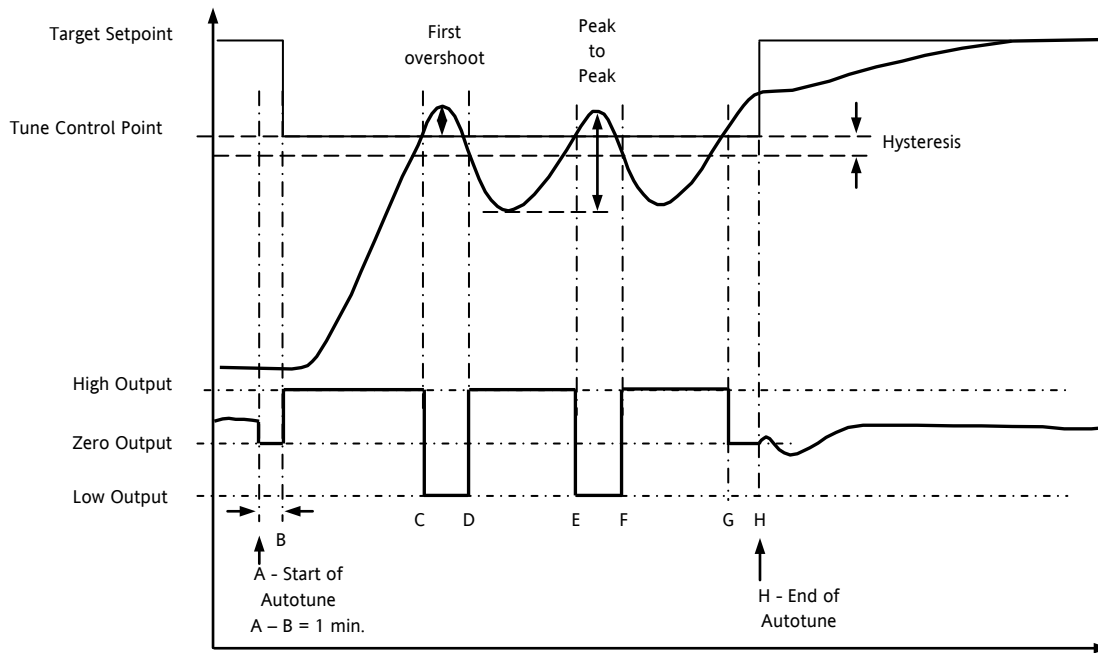

Period	Action
A	Start of Autotune
A to B	Both heating and cooling power remains off for a period of 1 minute to allow the algorithm to establish steady state conditions.
B to D	First heat/cool cycle to establish first overshoot. 'CBLO' is calculated on the basis of the size of this overshoot (assuming it is not set to Auto in the initial conditions).
B to F	Two cycles of oscillation are produced from which the peak to peak response and the true period of oscillation are measured. PID terms are calculated
F to G	An extra heat stage is provided and all heating and cooling power is turned off at G allowing the plant to respond naturally. Measurements made during this period allow the relative cool gain 'R2G' to be calculated. 'CBHI' is calculated from CBLO*R2G.
H	Autotune is turned off at and the process is allowed to control at the target setpoint using the new control terms.

Autotune can also occur when the initial PV is above SP. The sequence is the same as tuning from below setpoint except that the sequence begins with full cooling applied at 'B' after the first one minute settling time.

11.3.6 Autotune From Below SP – Heat Only

The sequence of operation for a heat only loop is the same as that previously described for a heat/cool loop except that the sequence ends at 'F' since there is no need to calculate 'R2G'.

At 'F' autotune is turned off and the process is allowed to control using the new control terms.

Relative cool gain, 'R2G', is set to 1.0 for heat only processes.

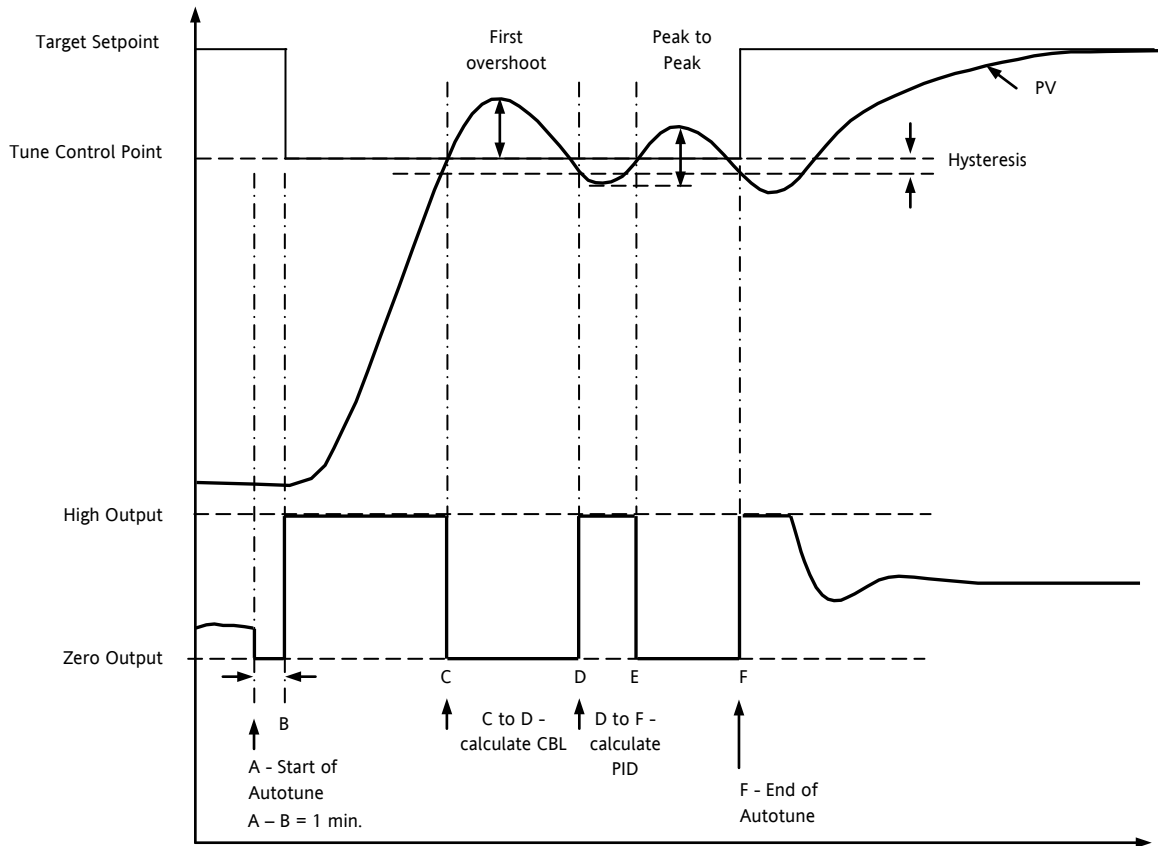

For a tune from below setpoint 'CBLO' is calculated on the basis of the size of the overshoot (assuming it was not set to Auto in the initial conditions). CBHI is then set to the same value as CBLO.

Note:- As with the heat/cool case, Autotune can also occur when the initial PV is above SP. The sequence is the same as tuning from below setpoint except that the sequence starts with natural cooling applied at 'B' after the first one minute settling time.

In this case CBHI is calculated – CBLO is then set to the same value as CBHI.

11.3.7 Autotune at Setpoint – Heat/Cool

It is sometimes necessary to tune at the actual setpoint being used. This is allowable in 3200 series controllers and the sequence of operation is described below.

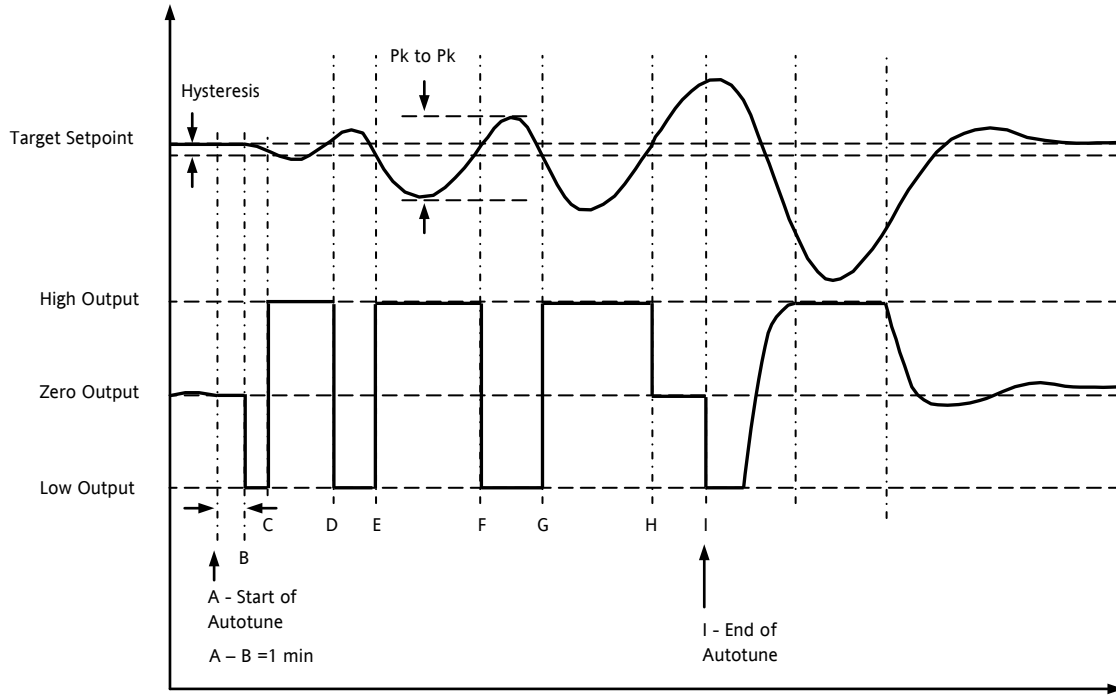

Period	Action
A	Start of Autotune. A test is done at the start of autotune to establish the conditions for a tune at setpoint. The conditions are that the SP must remain within 0.3% of the range of the controller if 'PB.UNT' is set to 'Percent'. If 'PB.UNT' is set to 'Eng' then the SP must remain within +1 engineering unit (1 in 1000). Range is defined as 'RNG.HI' – 'RNG.LO' for process inputs or the range defined in section 0 for temperature inputs.
A to B	The output is frozen at the current value for one minute and the conditions are continuously monitored during this period. If the conditions are met during this period autotune at setpoint is initiated at B. If at any time during this period the PV drifts outside the condition limits a tune at setpoint is abandoned. Tuning is then resumed as a tune from above or below setpoint depending on which way the PV has drifted. Since the loop is already at setpoint there is no need to calculate a Tune Control Setpoint – the loop is forced to oscillate around the Target Setpoint
C to G	Initiate oscillation - the process is forced to oscillate by switching the output between the output limits. From this the period of oscillation and the peak to peak response is measured. PID terms are calculated
G to H	An extra heat stage is provided and all heating and cooling power is turned off at H allowing the plant to respond naturally. Measurements made during this period allow the relative cool gain 'R2G' to be calculated.
I	Autotune is turned off and the process is allowed to control at the target setpoint using the new control terms.

For a tune at setpoint autotune does not calculate cutback since there was no initial start up response to the application of heating or cooling. The exception is that the cutback values will never be returned less than 1.6*PB.

11.3.8 Manual Tuning

If for any reason automatic tuning gives unsatisfactory results, you can tune the controller manually. There are a number of standard methods for manual tuning. The one described here is the Ziegler-Nichols method.

Adjust the setpoint to its normal running conditions (it is assumed this will be above the PV so that heat only is applied)

Set the Integral Time 'TI' and the Derivative Time 'TD' to 'OFF'.

Set High Cutback 'CBHI' and Low Cutback 'CBLO' to 'Auto'.

Ignore the fact that the PV may not settle precisely at the setpoint.

If the PV is stable, reduce the proportional band so that the PV just starts to oscillate. Allow enough time between each adjustment for the loop to stabilise. Make a note of the proportional band value 'PB' and the period of oscillation 'T'. If PV is already oscillating measure the period of oscillation 'T', then increase the proportional band until it just stops oscillating. Make a note of the value of the proportional band at this point.

Set the proportional band, integral time and derivative time parameter values according to the calculations given in the table below:-

Type of control	Proportional band (PB)	Integral time (TI) seconds	Derivative time (TD) seconds
Proportional only	2xPB	OFF	OFF
P + I control	2.2xPB	0.8xT	OFF
P + I + D control	1.7xPB	0.5xT	0.12xT

11.3.9 Manually Setting Relative Cool Gain

If the controller is fitted with a cool channel this should be enabled before the PID values calculated from the table above are entered.

Observe the oscillation waveform and adjust R2G until a symmetrical waveform is observed.

Then enter the values from the table above.

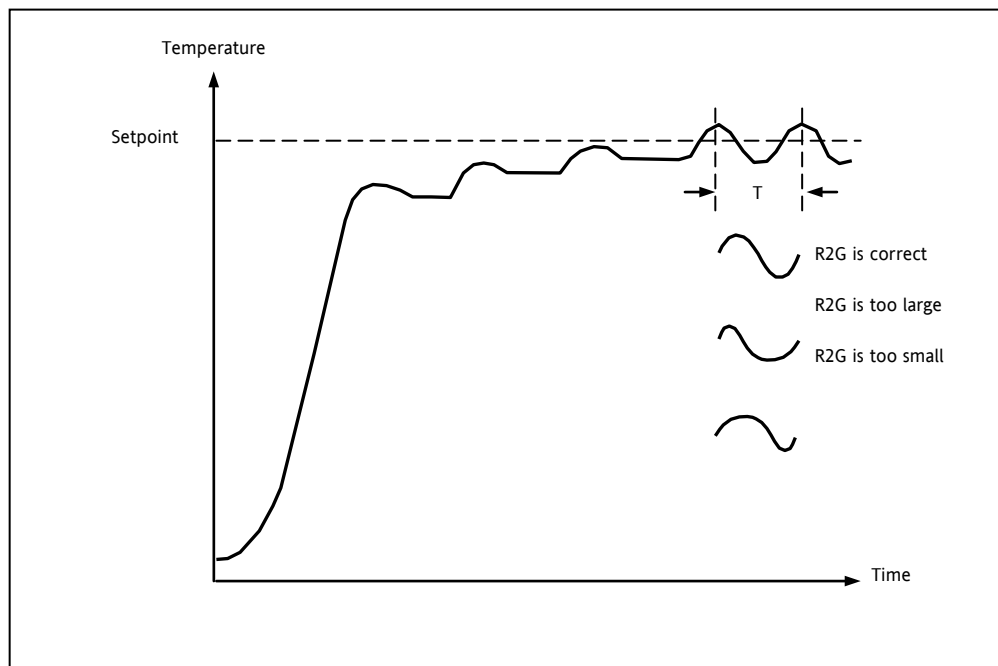

11.3.10 Manually Setting the Cutback Values

Enter the PID terms calculated from the table in section 11.3.8 before setting cutback values.

The above procedure sets up the parameters for optimum steady state control. If unacceptable levels of overshoot or undershoot occur during start-up, or for large step changes in PV, then manually set the cutback parameters.

Proceed as follows:

Initially set the cutback values to one proportional bandwidth converted into display units. This can be calculated by taking the value in percentage that has been installed into the parameter 'PB' and entering it into the following formula:-

$PB/100 * \text{Span of controller} = \text{Cutback High and Cutback Low}$

For example, if $PB = 10\%$ and the span of the controller is $0 - 1200^{\circ}\text{C}$, then

$\text{Cutback High and Low} = 10/100 * 1200 = 120$

If overshoot is observed following the correct settings of the PID terms increase the value of 'CBLO' by the value of the overshoot in display units. If undershoot is observed increase the value of the parameter 'CBHI' by the value of the undershoot in display units.

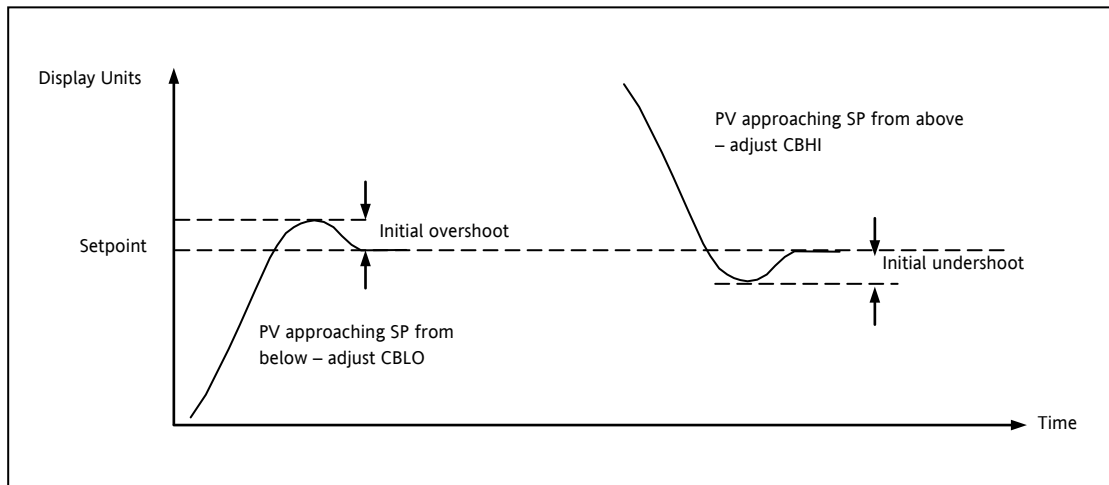

11.4 Auto-tune Configures R2G

In a system which controls both heating and cooling the parameter R2G sets the cooling proportional band to compensate for differences between the power available to heat, and that available to cool a process, see section 11.2.4. There are certain load conditions where auto-tune may set an incorrect value for R2G. This will be seen as instability in the control of the process after an auto-tune has been completed. In these circumstances check the value of R2G. If it is low (approaching 0.1) AND the process is unstable it is necessary to manually determine a value of R2G and enter this before carrying out a second auto-tune.

Note: it is only necessary to do this if the process causes the condition described above.

A parameter has been added (in 3200 controllers supplied after Dec 08) which provides the option to suppress the auto tuning of R2G allowing it to be set manually. The parameter is called AT.R2G (Auto-tune R2G) and may be set to YES or NO. YES is the default which means that R2G will be set automatically. NO requires a value for R2G to be entered manually.

The sequence is as follows:-

- 1) Set AT.R2G to NO.
- 2) Enter a value for R2G. See the example below.
- 3) Calculate and enter a value for the TUNE LOW LIMIT from 'OP.LO' = -OP.HI x R2G. See Note 2.
- 4) Start Auto-tune

Example - To establish a value for R2G.

One way to approximate a suitable value for R2G is to measure the heating and cooling rates around the normal operating temperature of the system.

- 1) Measure the heating and cooling rates of the process:-

- a) Put the controller into Manual mode and turn heating power ON (limited by OP.HI).
- b) Allow the process to heat from below normal operating setpoint and for the actual temperature to pass through the normal operating setpoint. When the actual temperature is (say 10%) above normal working temperature turn off the heat.
- c) Allow the temperature to settle then turn cooling power ON (limited by OP.LO). Allow the temperature to fall below normal working setpoint.

A graphical example of the results is shown below:-

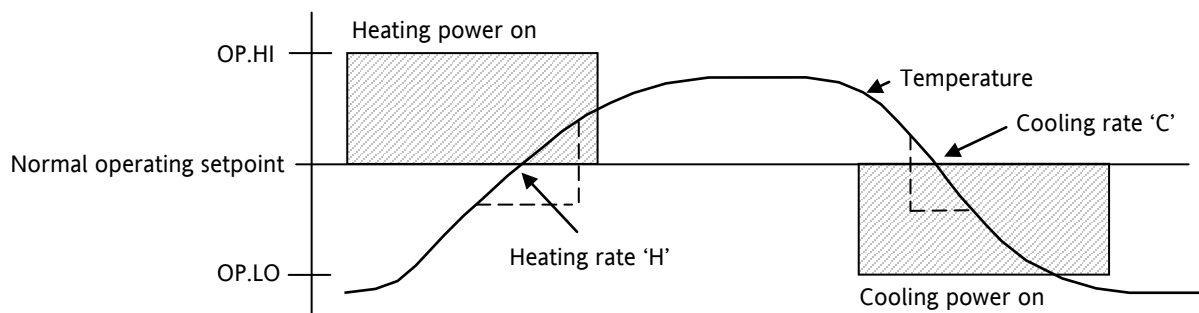

- 2) Calculate R2G from $R2G = (H/C) * (OP.LO/OP.HI)$

For example Heating rate 'H' = 10°C per minute, Cooling rate 'C' = 25 °C per minute, OP.HI = 80%, OP.LO = 40% then R2G = 0.2

Enter a value of 0.2 for R2G























Note 1: This calculation will compensate for the different output limits set by OP.HI and OP.LO.

Note 2: If the calculated value for TU.LO is greater than the output limit set by OP.LO, continue to enter the calculated value.

Note 3: It is envisaged that this procedure would normally be carried out by the equipment manufacturer. However, once the value of R2G has been determined and AT.R2G has been set to NO, autotuning your process from then on can be repeated by simply selecting ATUNE = On (assuming, of course, that the characteristics of the process have not changed significantly).

11.5 Example: To Configure Heating and Cooling

Enter configuration level as described. Then:-

Do This	The Display You Should See	Additional Notes
1. Press  as many times as necessary to select 'CTRL'		
2. Press  to scroll to 'CTRLH'		Heating Type choices are:- <i>Pi d</i> PID (3 term) control <i>on</i> On/Off control <i>off</i> No heating output configured
3. Press  or  to select the Heating Type		
4. Press  to select 'CTRL.C'		Cooling Type choices are:- <i>off</i> No cooling output configured <i>Pi d</i> PID (3 term) control <i>on</i> On/Off control
5. Press  or  to select the Cooling Type		
6. Press  to select 'CTRL.A'		Control Action choices are:- <i>rEu</i> Reverse - heating control <i>dir</i> Direct - cooling only control
7. Press  or  to 'rEu'		
8. Press  to scroll to 'PB.UNT'		Proportional Band Units choices are:- <i>ENG</i> Engineering units <i>PERC</i> Percentage
9. Press  or  to choose units		
10. Continue to select parameters using  for example 'OP.HI'		When PID control is selected, this places a limit on the output demand from the PID which can be applied to the heating circuit.
11. Press  or  to change their values		' <i>OP.LD</i> ' can be set up in the same way if required. If on/off control is selected these parameters do not apply. They are replaced by 'HYST.H' and 'HYST.L' to set the difference between the output switching off to switching on.

11.5.1 Effect of Control Action, Hysteresis and Deadband

For temperature control 'CONTROL ACTION' will be set to 'rE'. For a PID controller this means that the heater power decreases as the PV increases. For an on/off controller output 1 (usually heat) will be on (100%) when PV is below the setpoint and output 2 (usually cool) will be on when PV is above the setpoint

Hysteresis applies to on/off control only. It defines the difference in temperature between the output switching off and switching back on again. The examples below show the effect in a heat/cool controller.

Deadband can operate on both on/off control or PID control where it has the effect of widening the period when no heating or cooling is applied. However, in PID control its effect is modified by both the integral and derivative terms. Deadband might be used in PID control, for example, where actuators take time to complete their cycle thus ensuring that heating and cooling are not being applied at the same time. Deadband is likely to be used, therefore, in on/off control only. The second example below adds a deadband of 20 to the above example.

In an on/off controller, if CONTROL ACTION = rev then OP2 will be on when PV is below SP. OP1 will be on when the PV is above SP. The outputs are, therefore, reversed in the above example.

Deadband OFF

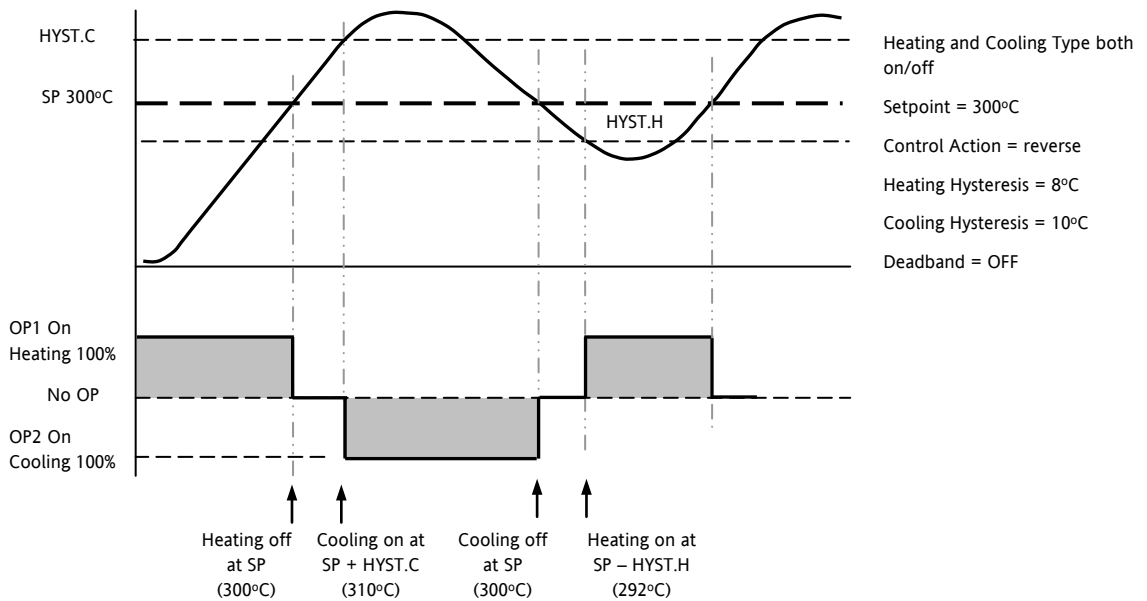

Deadband ON

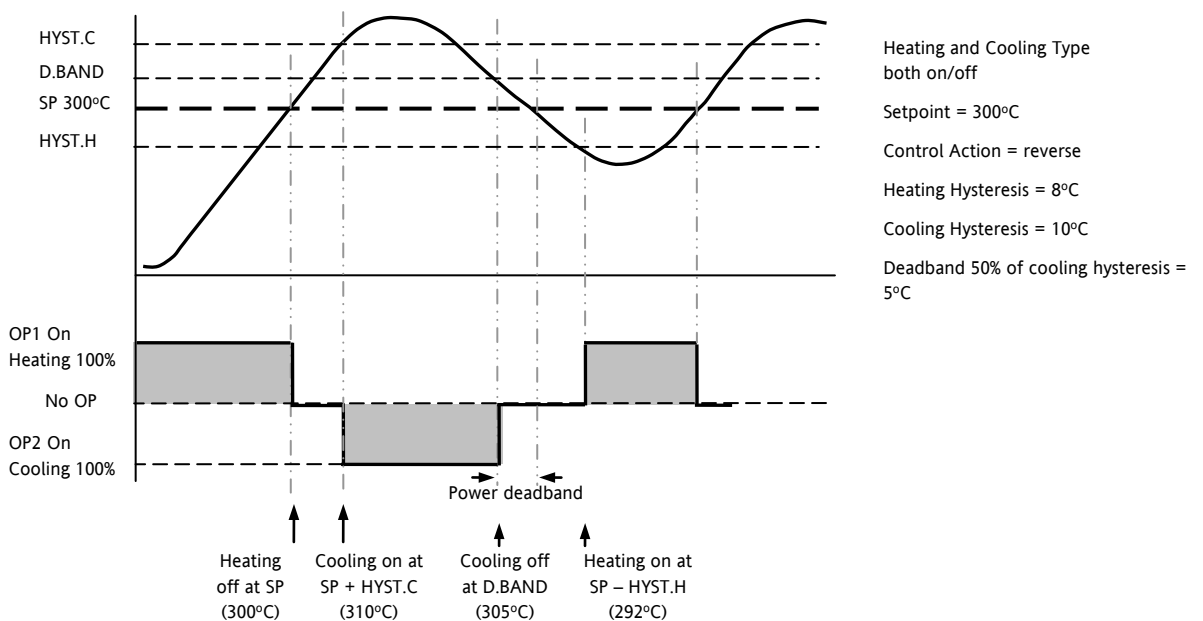

12. Alarms

Alarms are used to alert an operator when a pre-set level has been exceeded. They are indicated by a scrolling message on the display and the red ALM beacon. They may also switch an output— usually a relay (see section 12.1.1) – to allow external devices to be operated when an alarm occurs. Alarms only operate if they have been ordered and configured.

Up to eight different alarms are available:-

- **Alarm 1:** configurable as full scale high or low, band or deviation high or low
- **Alarm 2:** configurable as full scale high or low, band or deviation high or low
- **Alarm 3:** configurable as full scale high or low, band or deviation high or low
- **Alarm 4:** configurable as full scale high or low, band or deviation high or low
- **Sensor Fault alarm.** An alarm condition - INPUT SENSOR BROKEN (*Sbr*) is indicated if the sensor or the wiring between sensor and controller becomes open circuit. The output level will adopt a 'SAFE' value which can be set up in Operator Level 2, see section 11.2.
- For a PRT input, sensor break is indicated if any one of the three wires is broken.
For mA input sensor break will not be detected due to the load resistor connected across the input terminals.
For Volts input sensor break may not be detected due to the potential divider network connected across the input terminals.
- **Loop Break alarm.** Displayed as CONTROL LOOP BROKEN. This occurs if the controller does not detect a change in process value following a change in output demand after a suitable delay time.
- **Current Transformer alarms – Leak, Load Fail, Overcurrent** (see C/T section 9.2)
- **Remote Fail Alarm.** This alarm operates on the remote setpoint input. If a value is not received after a period of 5 seconds, then the Remote Fail Alarm is shown.

12.1 Types of Alarm

This section shows graphically the operation of different types of alarm used in the controller. The graphs show changes in temperature plotted against time. (Hysteresis set to zero)

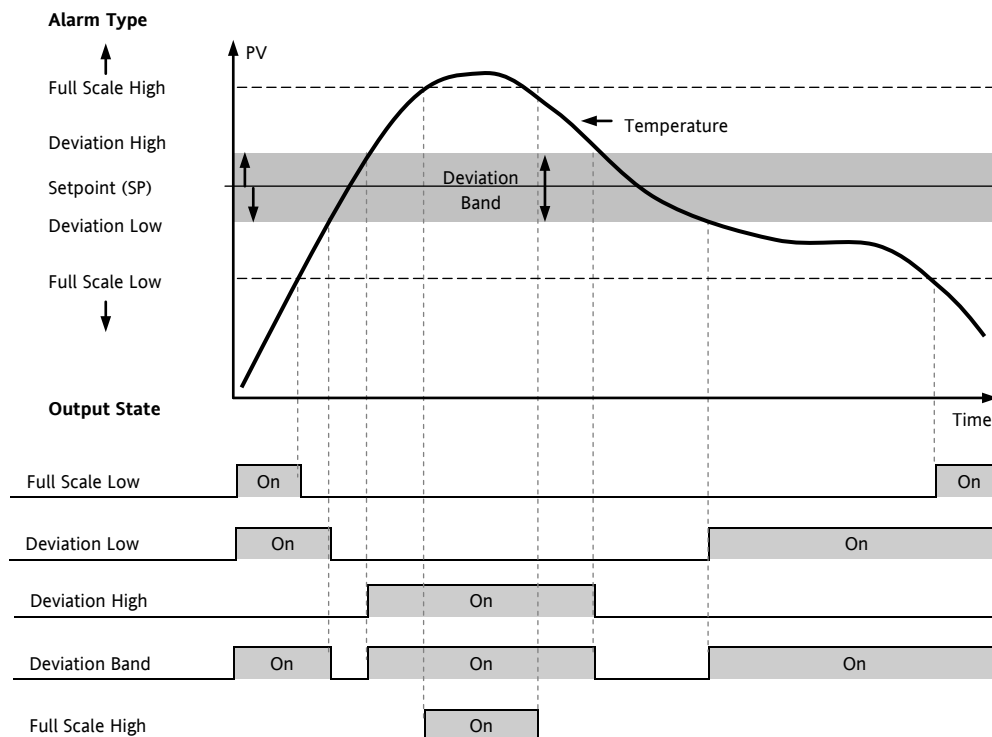

Hysteresis	Hysteresis is the difference between the point at which the alarm switches 'ON' and the point at which it switches 'OFF'. It is used to provide a definite indication of the alarm condition and to prevent alarm relay chatter.	
Latching Alarm	Latching is used to maintain the alarm condition once an alarm has been detected. It may be configured as:-	
	<i>nonE</i>	Non latching A non latching alarm will reset itself when the alarm condition is removed
	<i>Auto</i>	Automatic An auto latching alarm requires acknowledgement before it is reset. The acknowledgement can occur BEFORE the condition causing the alarm is removed.
	<i>mAn</i>	Manual The alarm continues to be active until both the alarm condition is removed AND the alarm is acknowledged. The acknowledgement can only occur AFTER the condition causing the alarm is removed.
	<i>Evt</i>	Event ALM beacon does not light but an output associated with this parameter will activate. A scrolling message may be configured using iTools, as described in section 17.7. If a message has been configured it will scroll across the display while the event is true.
Blocking Alarms	The alarm may be masked during start up. Blocking prevents the alarm from being activated until the process has first achieved a safe state. It is used to ignore start up conditions which are not representative of running conditions. A blocking alarm is re-initiated after a setpoint change. See section 12.2 for an explanation of the behaviour of blocking alarms under different conditions.	

From firmware version 2.11, two rate of change alarms are available. These are:-

Rising rate of change (units/minute)	An alarm will be detected if the rate of change in a positive direction exceeds the alarm threshold
--------------------------------------	---

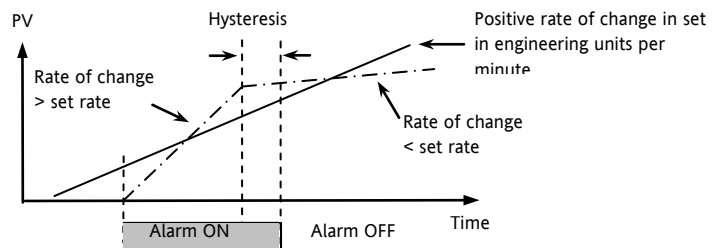

Falling rate of change (units/minute)	An alarm will be detected if the rate of change in a negative direction exceeds the alarm threshold
---------------------------------------	---

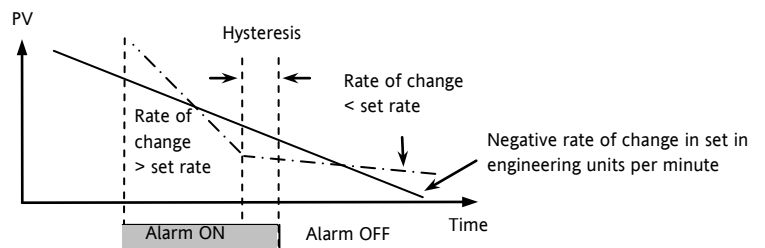

12.1.1 Alarm Relay Output

Alarms can operate a specific output (usually a relay). Any individual alarm can operate an individual output or any combination of alarms, up to four, can operate an individual output. They are either supplied pre-configured* in accordance with the ordering code or set up in configuration level.

* When supplied pre-configured, the default is:-

IO1 is always AL1

OP2 is always AL2

OP3 is always AL3

OP4 (AA) is always AL4

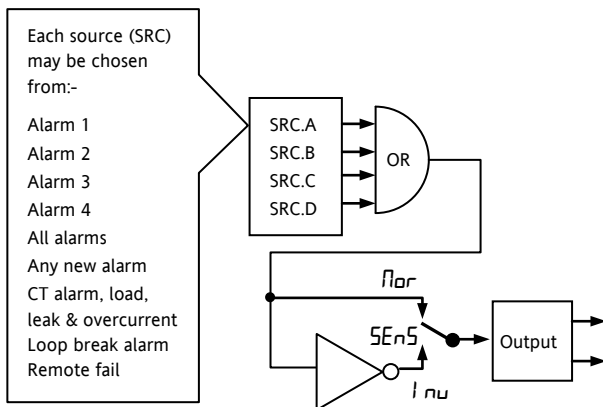

12.1.2 Alarm Indication

- ALM beacon flashing red = a new alarm (unacknowledged)
- This is accompanied by a scrolling alarm message. A typical default message will show the source of the alarm followed by the type of alarm. For example, 'ALARM 1 FULL SCALE HIGH'
- Using Eurotherm iTools configuration package, it is also possible to download customised alarm messages. An example might be, 'PROCESS TOO HOT'.
- If more than one alarm is present further messages are flashed in turn in the main display. The alarm indication will continue while the alarm condition is present and is not acknowledged.
- ALM beacon on continuously = alarm has been acknowledged

12.1.3 To Acknowledge An Alarm

Press  and  together.

The action, which now takes place, will depend on the type of latching, which has been configured.

Non-Latched Alarms

Alarm condition present when the alarm is acknowledged.

- ALM beacon on continuously.
- The alarm message(s) will continue to scroll

This state will continue for as long as the alarm condition remains. When the alarm condition disappears all indication also disappears.

If a relay has been attached to the alarm output, it will de-energise when the alarm condition occurs and remain in this condition until acknowledged or the alarm is no longer present.

If the alarm condition disappears before it is acknowledged the alarm resets immediately.

Latched Alarms

See description in section 12.1.

12.2 Behaviour of Alarms After a Power Cycle

The response of an alarm after a power cycle depends upon the latching type, whether it has been configured to be a blocking alarm, its state and the acknowledge status of the alarm.

The response of active alarms after a power cycle is as follows:

For a non-latching alarm or an event alarm blocking will be re-instated, if configured. If blocking is not configured the active alarm will remain active. If the alarm condition has gone safe during the down time the alarm will return inactive.

For an auto-latching alarm blocking will be re-instated, if configured, only if the alarm had been acknowledged prior to the power cycle. If blocking is not configured or the alarm had not been acknowledged the active alarm will remain active. If the alarm condition has gone safe during the downtime the alarm will return inactive if it had been acknowledged prior to the power cycle else it will return safe but not acknowledged. If the alarm was safe but not acknowledged prior to the power cycle the alarm will return safe but not acknowledged.

For a manual-latching alarm blocking will not be re-instated and the active alarm will remain active. If the alarm condition has gone safe during the downtime the alarm will return safe but not acknowledged. If the alarm was safe but not acknowledged prior to the power cycle the alarm will return safe but not acknowledged.

The following examples show graphically the behaviour under different conditions:-

12.2.1 Example 1

Alarm configured as Absolute Low; Blocking: No Latching

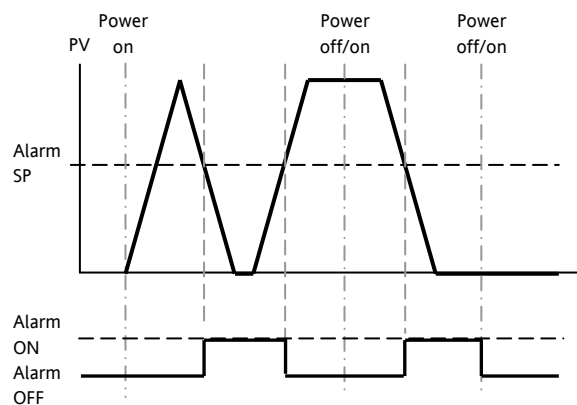

12.2.2 Example 2

Alarm configured as Absolute Low; Blocking: Manual Latching

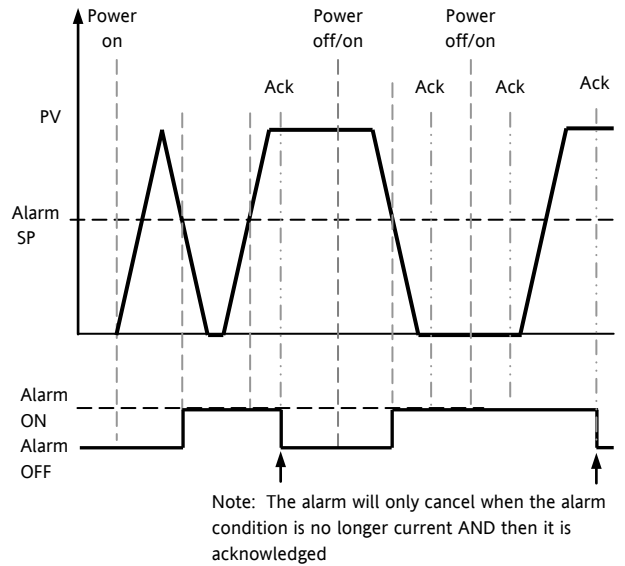

12.2.3 Example 3

Alarm configured as Absolute Low; Blocking: Auto Latching

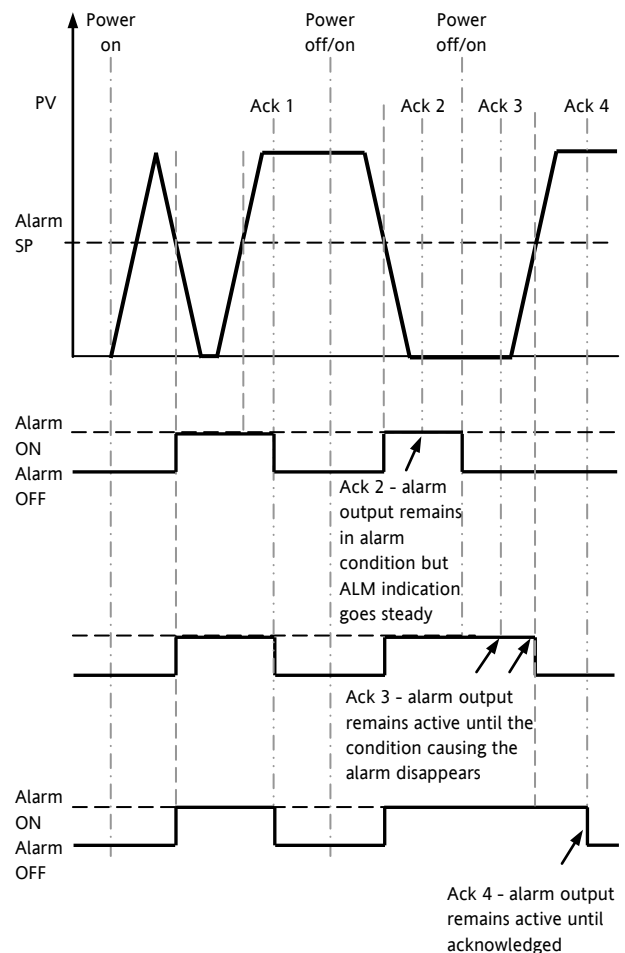

12.3 Alarm Parameters

























Four alarms are available. Parameters do not appear if the Alarm Type = None. The following table shows the parameters to set up and configure alarms.

ALARM LIST		'ALARM'				
Name	Scrolling Display	Parameter Description	Value		Default	Access Level
AL1TYP	ALARM 1 TYPE	Selects the type of alarm	nonE	Alarm not configured	As order code	Conf
			Hi	Full Scale High		
			Lo	Full Scale Low		
			dHi	Deviation High		
			dLo	Deviation Low		
			bnd	Deviation band		
			rrc	Rising rate of change, set in 1-9999 eng units/min		
			Frc	Falling rate of change set in 1-9999 eng units/min		
AL1---	ALARM 1 SETPOINT	Alarm 1 threshold value. The last three characters show the type of alarm configured from the above list	Instrument range		0	L3
AL1STS	ALARM 1 OUTPUT	Indicates the status of the alarm	OFF	Alarm off		Read only
			On	Alarm on		
AL1HYS	ALARM 1 HYSTERESIS	See description at the beginning of this section	0 to 9999			Conf
AL1LAT	ALARM 1 LATCHING TYPE	See description at the beginning of this section	nonE	Non-latching	As order code	Conf
			Auto	Latching with automatic resetting		
			mAn	Latching with manual resetting		
			Evt	Event (no alarm flashing beacon but messages can be displayed)		
AL1BLK	ALARM 1 BLOCKING	See description at the beginning of this section	No	No blocking	No	Conf
			YES	Blocking		

The above parameters are repeated for Alarm 2, AL2; Alarm 3, AL3; Alarm 4, AL4

12.3.1 Example: To Configure Alarm 1

Enter configuration level as described. Then:-

Do This	The Display You Should See	Additional Notes
1. Press  as many times as necessary to select 'ALARM'		
2. Press  to select 'A1.TYP' 3. Press  or  to select the required alarm type		Alarm Type choices are:- <i>nonE</i> Alarm not configured <i>H1</i> Full Scale High <i>L0</i> Full Scale Low <i>dH1</i> Deviation High <i>dL0</i> Deviation Low <i>bnd</i> Deviation Band
4. Press  to select 'A1.--' 5. Press  or  to set the alarm trip level		This is the alarm threshold setting for. The last three characters (---) will show the type of alarm configured from the above list. The alarm threshold is shown in the upper display. In this example the high alarm will be detected when the measured value exceeds 215
6. Press  to select 'A1 STS'		This is a read only parameter which shows the status of the alarm output
7. Press  to select 'A1 HYS' 8. Press  or  to set the hysteresis		In this example the alarm will cancel when the measured value decreases 2 units below the trip level (at 213 units)
9. Press  to select 'A1 LAT' 10. Press  or  to select the latching type		Latching Type choices are:- <i>nonE</i> No latching <i>Auto</i> Automatic <i>mAn</i> Manual <i>EvE</i> Event See the introduction to the alarm section for an explanation
11. Press  to select 'A1 BLK' 12. Press  or  to 'YES' or 'No' 13. Repeat the above to configure alarms 2, 3 and 4 if required		

12.4 Diagnostic Alarms

Diagnostic alarms indicate a possible fault within the controller or connected devices.

Display shows	What it means	What to do about it
<i>EConF</i>	A change made to a parameter takes a finite time to be entered. If the power to the controller is turned off before the change has been entered then this alarm will occur. Do not turn the power off to the controller while <i>EConF</i> is flashing	Enter configuration mode then return to the required operating mode. It may be necessary to re-enter the parameter change since it will not have been entered in the previous configuration.
<i>ECAL</i>	Calibration error	Re-instate Factory calibration
<i>EEP-</i>	EEPROM error	Return to factory for repair
<i>EEE-</i>	Non-vol memory error	Note the error and contact your supplier
<i>ELi n</i>	Invalid input type. This refers to custom linearisation which may not have been applied correctly or may have been corrupted.	Go to the INPUT list in configuration level and set a valid thermocouple or input type
<i>Emod</i>	IO1, OP2, or OP3 has been changed	If this has been field changed by the installation of a new board, enter config level, then exit back to operator level. If the message occurs at any other time return to factory for repair.

12.4.1 Out of Range Indication

If the input is too high HHHHH will be displayed

If the input is too low LLLLL will be displayed

13. Timer/Programmer

A timer can be configured to operate in one of four different modes. These can be selected in Level 3 or configuration level as:-

1. Dwell timer
2. Delay timer
3. Soft start timer
4. Programmer – this is an orderable option

Operation of the timer has been described in section 5.

13.1 Timer Parameters

The full list of all available parameters in configuration level is given in the following table.

TIMER LIST						
'TIMER'						
Name	Scrolling Display	Parameter Description	Value		Default	Access Level
TM.CFG	TIMER CONFIGURATION	Timer type configuration	nonE	Timer disabled	As order code	L3
			dwEII	Dwell		
			dELY	Delayed switch on		
			SFSt	Soft start		
			Prog	Programmer		
TM.RES	TIMER RESOLUTION	To set the time units	Hour	Hours HH:MM		Conf R/O L3
			min	Minutes MM:SS		
THRES	TIMER START THRESHOLD	To set the maximum deviation between SP and PV before the timer starts. Dwell timer and Programmer only	OFF or 1 to 3000 Units above and below setpoint		OFF	L3
ENDET	TIMER END TYPE	To determine the action which takes place when the timer has timed out. Dwell timer and Programmer only	OFF	Control outputs go to zero %		Conf
			dwEII	Control continues at SP1		
			SP2	Go to setpoint 2		
			rES	Reset programmer		
SS.SP	SOFT START SETPOINT	Sets the threshold below which the power is limited SFSt timer only	Controller input range		0	Conf
SS.PWR	SOFT START POWER LIMIT	Sets the limit to the power output during start up SFSt timer only	0 to 100%		0	Conf
T.STATUS	TIMER STATUS	Timer status	rES	Reset		L3
			run	Running (counting)		
			hoLd	Running (hold)		
			End	Timed out		
SERVO	SERVO MODE	Defines the way in which the programmer starts and how it recovers from a power failure See also section 5.8.1. Programmer only	SP	Starts at SP1 (or SP2). The program must be re-started after a power failure.	SP	
			PU	Starts at the current Process value. The program must be re-started after a power failure.		
			SPrb	Starts at SP1 (or SP2). The program will continue to run from the original setpoint value at the last ramp rate.		

TIMER LIST		'TIMER'				
Name	Scrolling Display	Parameter Description	Value		Default	Access Level
			<i>Purb</i>	Starts at the current Process value. The program will continue to run from the current process value and ramp back at the last ramp rate		
<i>TSP. 1</i>	TARGET SETPOINT 1	To set the target value for the first setpoint	Controller input range		0	L2
<i>RMP. 1</i>	RAMP RATE 1	To set the rate at which the setpoint changes to reach TSP.1	<i>OFF</i> , 0:1 to 3000 units per min or hour		<i>OFF</i>	L2
<i>DWEL. 1</i>	DWELL 1	To set the time at which the setpoint remains at TSP.1	<i>OFF</i> , 0:01 to 99:59 hh:mm or mm.ss		<i>OFF</i>	L2
The above three parameters are repeated for the next 3 program segments, i.e. TSP.2, (3 & 4), RMP.2 (3 & 4), DWEL.2 (3 & 4)						
<i>DWELL</i>	SET TIMER DURATION	To set the time duration (not programmer)	0:00 to 99:59 hh:mm or mm.ss		0	L3
<i>T.ELAP</i>	ELAPSED TIME	Time elapsed from when the timer starts to run	0:00 to 99.59 hh:mm or mm.ss			L3 read only
<i>T.REMN</i>	TIME REMAINING	Time remaining to reach the set time.	0:00 to 99.59 hh:mm or mm.ss			L3
<i>EVENT</i>	EVENT OUTPUTS	Event output operates during the selected segment Programmer only See section 13.2.3	0 = No events operate in any segment 255 == Events operate in all segments		0	L3
<i>P.CYCL</i>	PROGRAM CYCLES	Sets the number of times that a program is repeated	1 to 100		1	L3
<i>CYCLE</i>	PROGRAM CYCLE	Displays the current cycle when the program is running	1 to 100			L3
The timer can be restarted from the Reset condition by changing the time remaining parameter.						

13.2 Programmer

Function code CP is an eight segment programmer consisting of four ramp/dwell pairs. Each ramp consists of a controlled rate of change of setpoint to a target level. Each ramp is followed by a dwell at that level. The ramp rate, target level and dwell time are set by the user. The program profile is shown in the diagram below.

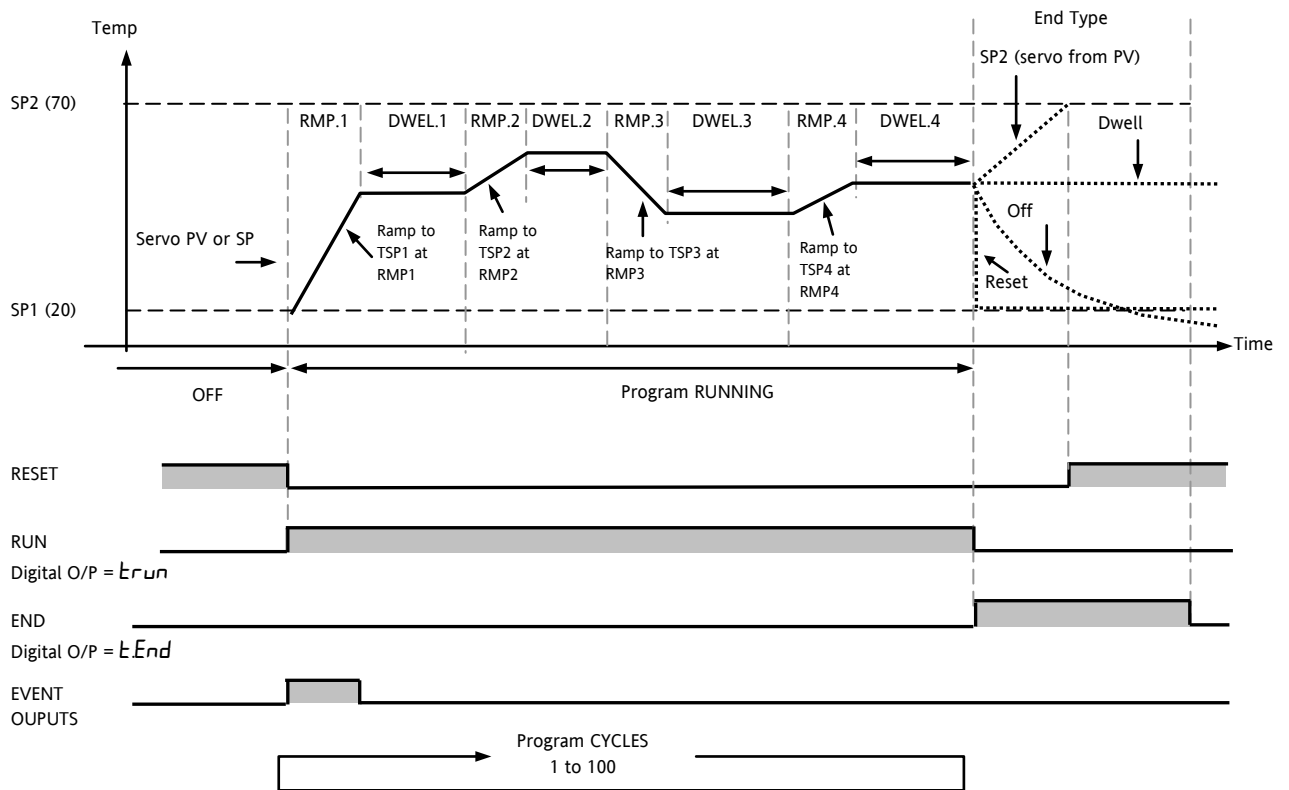

Notes:-

Where steps are required, the ramp rate in the ramp/dwell pair should be set to 'OFF'.

1. Where ramp/dwell pairs are not required, the ramp rate should be set to 'OFF' and the TSP the same as the preceding segment
2. TIMER END – when end type is SP2, Timer END does not occur until the ramp is complete or SP2 is achieved. It is more usual to use a DWELL End Type (the default setting)

13.2.1 Threshold

A single threshold value is available to provide a holdback on the entry to the dwell part of the ramp/dwell pair. It holds back the dwell until the PV has reached the band defined by +/- threshold around the PV as shown below:-

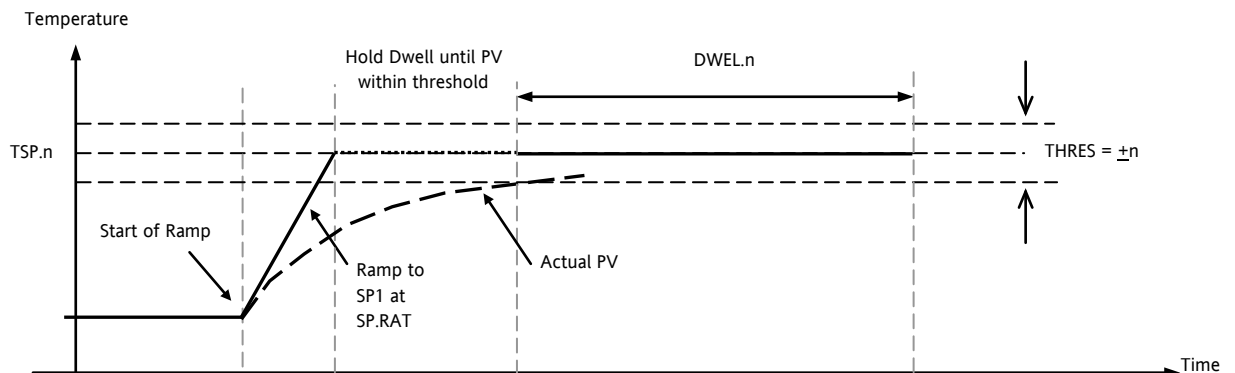

13.2.2 Run/End Digital Outputs

Digital outputs (normally relay) may be made to operate while the program is in Run mode or End mode, as shown in the diagram in section 13.2. These outputs are set up in configuration level by selecting the appropriate output parameter list - IO-1, OP-2, OP-3, or AA and assigning the parameter 'PrG.E' to the 'SRC.A' (B, C, or D) parameter.

The following example describes how to configure OP-2 to operate when the programmer is running and OP-3 to operate when the programme is complete. It is assumed that IO-1 is configured as the control output for a heat only controller.

1. Select Configuration level.
2. Press to scroll to **OP-2**
3. Press to scroll to **2.FUNC** and select **d.out** using or .
4. Press to scroll to **2.SRC.A** (or B or C or D) and select **t.run** using or .
5. Press to scroll to **OP-3**
6. Press to scroll to **3.FUNC** and select **d.out** using or .
7. Press to scroll to **3.SRC.A** (or B or C or D) and select **t.End** using or .

13.2.3 Event Output During a Segment

This feature was added after software version 2.

A digital event may be configured to operate in any segment of the program. This is set up in the TIMER List by the parameter 'EVENT'.

To turn an output on in a segment, use the table and diagram, below to obtain the **weighting** value for that segment. Note down the weightings for each segment in which the output is to be turned on and add them together. Set the Event Settings value to this number.

For example, to switch an output on in the first ramp segment and the second dwell, the weightings would be 1 and 8. So the Event Setting would be 9. To turn the event on in Ramp 1 and Dwell 3 the weightings would be 1 and 32, so the event setting would be 33. To turn the event on in Dwell 1, Dwell 3 and Dwell 4 the weightings would be 2 + 32 + 128 = 162. This is shown in the diagram below.

See also the example 'To Configure the Programmer' section 13.2.4.

Segment	Weighting
Ramp 1	1
Dwell 1	2
Ramp 2	4
Dwell 2	8
Ramp 3	16
Dwell 3	32
Ramp 4	64
Dwell 4	128

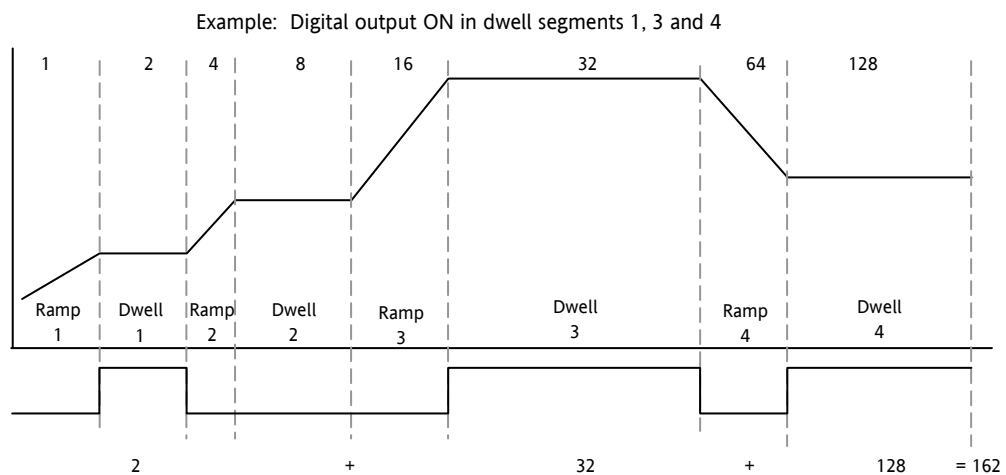





































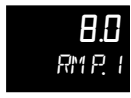







This event may be configured to operate an output. The following section (13.2.4.) configures output 4 to operate during a segment.

13.2.4 To Configure the Programmer

The programmer can be configured in Level 2 as explained in section 4. The Event outputs, however, can only be configured in Level 3 or Configuration level as follows:-

Select Access Level 3 or Configuration level as described in section 6.1.3.

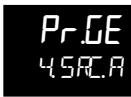
Operation	Action	Display View	Notes
Select the TIMER page	Press  as many times as necessary to 'TIMER'		
Configure the Timer as a Programmer	Press  to select 'TM.CFG' Press  or  to 'Prog'		
Set the Resolution	Press  to select 'TM.RES' Press  or  to 'Hour' or 'min'		This sets the dwell function in seconds, minutes or hours. In this example the dwell period is set in hours.
Set the Threshold	Press  to select 'THRES' Press  or  to adjust		In this example the dwell periods will not start until the PV is within 5 units of the setpoint
Set the action when the programmer times out	Press  to select 'END.T' Press  or  to 'OFF' or 'SP2' or 'dwell'		In this example the controller will continue to control indefinitely at the last setpoint. OFF will turn the output power off and SP2 will control at setpoint 2
Set the Servo Mode	Press  (twice) to select 'SERVO' Press  or  to 'PU' or 'SP'		In this example the program will start from the current value of the process variable
Set the first Target Setpoint	Press  to select 'TSP.1' Press  or  to adjust		In this example the setpoint will ramp from the current value of the PV to the first target - 100
Set the first Ramp Rate	Press  to select 'RMP.1' Press  or  to adjust		In this example the setpoint will ramp to 100 at 8.0 units per hour. The ramp units are set up in the Setpoint List see section 10.1.
Set the first Dwell	Press  to select 'DWEL.1' Press  or  to adjust		In this example the setpoint will dwell at 100 for 2 hours 11 minutes
Repeat the above three steps for all segments			
Set the segment in which the relay operates	Press  to select 'EVENT' Press  or  to adjust		Set as described in section 13.2.3. In this example the event output will be active during Ramp 2.
Set the number of times the whole program repeats	Press  to select 'P.CYCL' Press  or  to adjust		1 = Program runs once To 100 = Program repeats 100 times
Configure Output 4 (AA Relay) as the Event output	Press  to select 'AA' List Press  to select '4.SRC.A' Press  or  to select 'PrGE'		This can only be done in Configuration level. You can also select 4.SRC.B, 4.SRC.C, or 4.SRC.D or assign these to other functions, for example 'Erun' or 'EEnd' so that the relay also operates when the timer is running or when it ends. Note, however, if the same output is used to operate when the program is running it cannot also operate during a segment. In this case use an alternative output is described in section 13.2.2.

13.3 Example: To Configure a Dwell Timer as a Simple Two Step Programmer

If the instrument has been ordered as controller only, it is still possible to configure a simple ramp/dwell; ramp/dwell programmer.

This example assumes a hardware configuration as follows:-

- Output 2 Heat output relay
- I/O 1 Timer End digital output
- AA Relay Timer running digital output
- Dig Input Run/Reset input



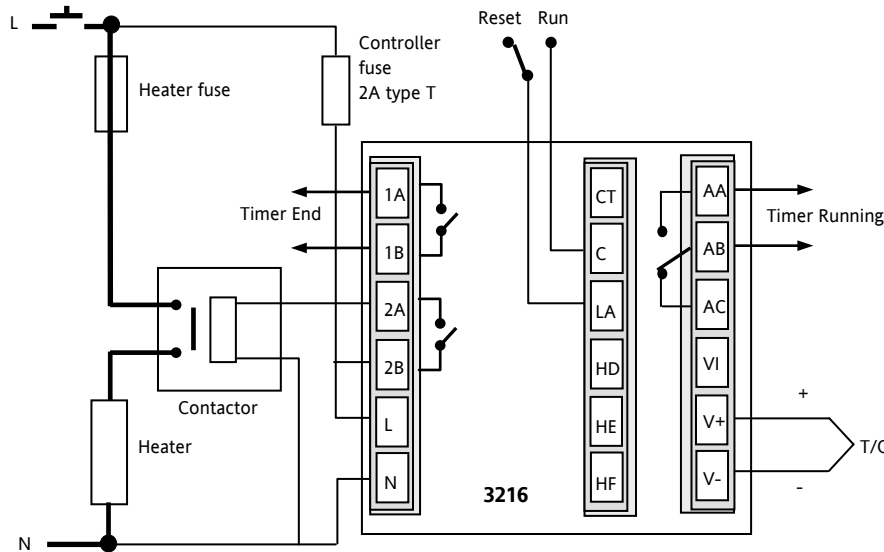













A typical wiring diagram for this example is shown below:-

















Configure the I/O as follows:-

Enter configuration level described in section 6.1.3. Then:-

Operation	Do This	Display View	Additional Notes
Select the IO-1 page header	1. Press as many times as necessary to select 'IO - 1'		To configure the timer end digital output signal Scrolling display 'IO - 1 LIST'
Set the output function to digital out	2. Press (twice) to select '1.FUNC' 3. Press or to choose <i>dout</i>		Scrolling display 'IO - 1 FUNCTION'
Wire source A so that IO-1 operates when the timer end status is true	4. Press to scroll to '1.SRC.A' 5. Press or to choose <i>tEnd</i>		Also <i>1.SRC.B 1.SRC.C 1.SRC.D = none</i> and <i>1.SENS = nor</i> to energise the relay when the timer is in the end state Scrolling display 'IO - 1 SOURCE'
Select the OP-2 page header	6. Press as many times as necessary to select 'OP - 2'		To configure the control output Scrolling display 'OUTPUT 2 LIST'
Set the output function to heat	7. Press to select '2.FUNC' 8. Press or to choose <i>HEAT</i>		Also <i>2.PLS = 50</i> and <i>2.SENS = nor</i> Scrolling display 'OUTPUT 2 FUNCTION'

Select the AA relay output list header	9. Press  as many times as necessary to select 'A A '		To configure the AA relay timer run digital output signal Scrolling display 'AA RELAY'
Set the output function to digital out	10. Press  to select '4. FUNC' 11. Press  or  to choose <i>dout</i>		Scrolling display 'OUTPUT 4 FUNCTION'
Wire source A so that the AA relay operates when the timer run status is true	12. Press  to select '4. SRC. A' 13. Press  or  to choose <i>trun</i>		Also 4 SRC. B 4 SRC. C 4 SRC. D = <i>nonE</i> and 4 SENS = <i>nor</i> to energise the relay when the timer is in the running state Scrolling display 'OUTPUT 4 SOURCE'
Select the LA digital input list header	14. Press  as many times as necessary to select 'L A '		To configure the LA digital input to Run/Reset the timer from an external contact
Set the input to Run/Reset the timer	15. Press  to select 'L .D.I.N ' 16. Press  or  to choose <i>trrs</i>		Make to Run, break to Reset



Configure the Timer

Operation	Do This	Display View	Additional Notes
Select the Timer list header	17. Press  as many times as necessary to select 'T I M E R '		To configure the timer. This can also be done in Level 3. Scrolling display 'TIMER LIST'
Configure the timer as a Dwell type	18. Press  to select 'TM. CFG' 19. Press  or  to choose <i>dwEll</i>		Also TM .RES = <i>min</i> or <i>Hour</i> as required Scrolling display 'TIMER CONFIGURATION'
Set the threshold to a level acceptable to the process	20. Press  to select 'THRES' 21. Press  or  to choose 2		To ensure the dwell starts when PV reaches 2^o of setpoint Scrolling display 'TIMER START THRESHOLD'
When the timer times out reset it to setpoint 2	22. Press  to select 'END. T' 23. Press  or  to choose <i>SP2</i>		Also set DWELL to the time period required Scrolling display 'TIMER END TYPE'

Return to Level 3 and operate the timer as previously described below

Assume the following settings

SP1 = 70°C End.T = SP2 = 20°C Ramp Rate (SP.RAT) = 20°C/min

The threshold value behaves like a holdback value and can be turned off. A digital output can be configured to operate an external buzzer, or other form of indication, to alert the operator to the end of the process. It is cancelled by pressing 'Ack' and  and .

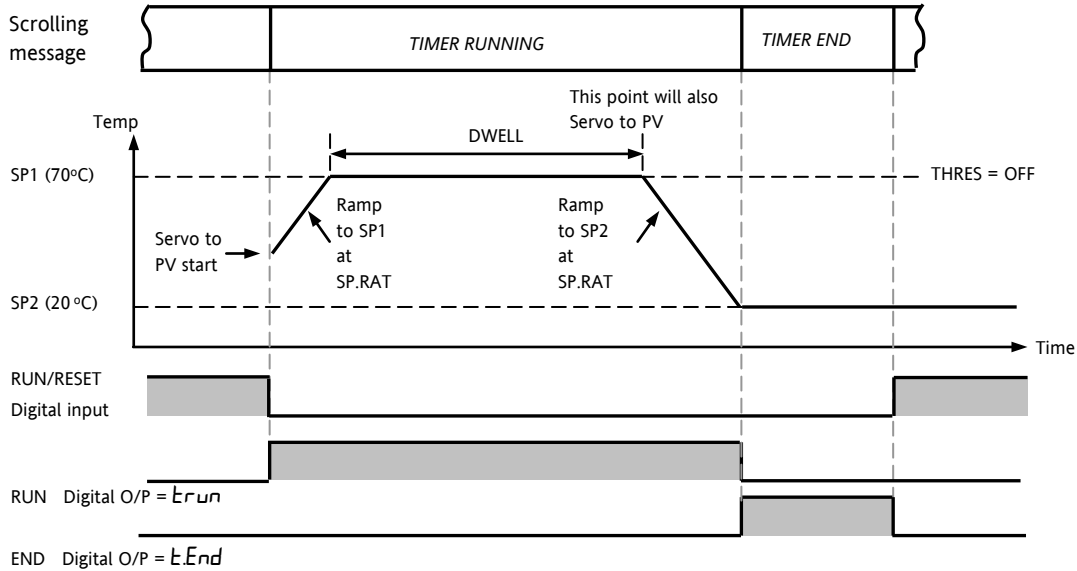

Threshold value turned off

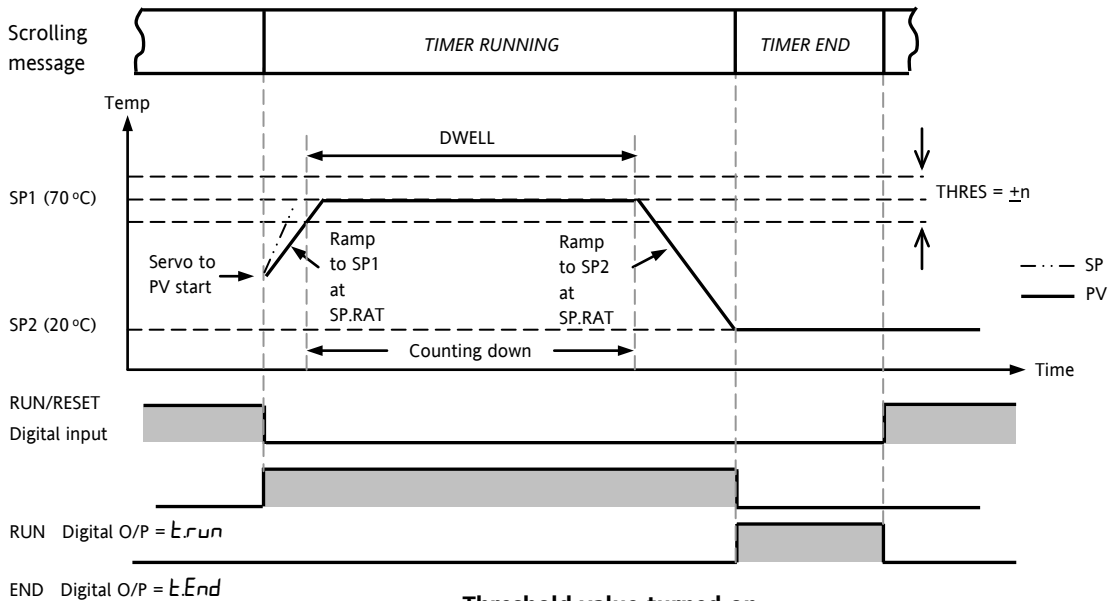

Threshold value turned on

This now behaves as a simple four segment programmer of two ramps two dwells.







14. Recipe

A recipe can take a snapshot of the current values and store these into a recipe number.

There are five recipes available, which can store a range of parameter values for different processes. The list of parameters is shown in section 14.3.1.

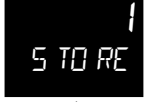







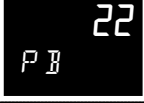

Each recipe can be given a name using iTools configuration software. It is also possible to reconfigure which parameters are included in the recipe list using iTools, see section 17.

14.1 To Save Values in a Recipe







Do This	The Display You Should See	Additional Notes
1. Press  as many times as necessary to select 'R E C I P'		Scrolling display <i>REC I P E L I S T</i>
2. Press  to scroll to 'STORE'		Scrolling display <i>REC I P E T O S A V E</i>
3. Press  or  to choose the recipe number to store eg 1		The current parameter values are stored in Recipe 1

14.2 To Save Values in a Second Recipe

In this example the proportional band will be changed and stored in recipe 2. All other values will remain the same as recipe 1:-

Do This	The Display You Should See	Scrolling display Additional Notes
1. Press  to scroll to 'CTRL'		Scrolling display <i>CONTROL L I S T</i>
2. Press  to scroll to PB		Scrolling display <i>PROPORTIONAL BAND</i>
3. Press  or  to change the value eg 22		
4. Press  to scroll to 'RECIP'		Scrolling display <i>REC I P E L I S T</i>
5. Press  to 'STORE'		Scrolling display <i>REC I P E T O S A V E</i>
6. Press  or  to 2		

14.3 To Select a Recipe to Run

Do This	The Display You Should See	Additional Notes
1. Press  as many times as necessary to select 'R E C I P'		Scrolling display <i>R E C I P E L I S T</i>
2. Press  to select 'R E C . N O'		Scrolling display <i>C U R R E N T R E C I P E N U M B E R</i>
3. Press  or  to choose recipe number e.g. 1		The values stored in Recipe 1 will now be loaded. If a recipe number is chosen which has not been saved then <i>F A I L</i> will be displayed

14.3.1 List of Default Recipe Parameters:

Instrument resolution is always saved and restored, as are instrument units, proportional band units and dwell resolution. The following parameters are the other default recipe parameters.

<i>P B</i>	Proportional Band	<i>R 1 . X X</i>	Alarm 1 threshold1
<i>T I</i>	Integral time	<i>R 2 . X X</i>	Alarm 2 threshold2
<i>T D</i>	Derivative time	<i>R 3 . X X</i>	Alarm 3 threshold3
<i>D . B A N D</i>	Channel 2 deadband	<i>R 4 . X X</i>	Alarm 4 hreshold4
<i>C B . L O</i>	Cutback low	<i>L B T</i>	Loop break time
<i>C B . H I</i>	Cutback high	<i>H Y S T . H</i>	Channel 1 hysteresis
<i>R 2 G</i>	Relative cool gain	<i>H Y S T . C</i>	Channel 2 hysteresis
<i>S P 1</i>	Setpoint 1	<i>H O M E</i>	Home Display
<i>S P 2</i>	Setpoint 2	<i>S P . H I</i>	Setpoint High limit
<i>M R</i>	Manual reset On/off only	<i>S P . L O</i>	Setpoint Low limit
<i>O P . H I</i>	Output high limit	<i>T M . C F G</i>	Timer configuration
<i>O P . L O</i>	Output low limit	<i>T M . R E S</i>	Timer reset
<i>S A F E</i>	Safe Output	<i>S S . S P</i>	Soft start setpoint
<i>S P . R A T</i>	Setpoint rate limit	<i>S S . P W R</i>	Soft start power limit
<i>R 1 . H Y S</i>	Alarm 1 hysteresis	<i>D W E L L</i>	Set time duration
<i>R 2 . H Y S</i>	Alarm 2 hysteresis	<i>T H R E S</i>	Timer Threshold
<i>R 3 . H Y S</i>	Alarm 3 hysteresis	<i>E N D . T</i>	Timer End Type
<i>R 4 . H Y S</i>	Alarm 4 hysteresis	<i>R A M P U</i>	Ramp Units
		<i>T . S T A T</i>	Programmer/Timer status

Recipes can also be set up using iTools configuration software – see section 17.10.

15. Digital Communications

Digital Communications (or 'comms' for short) allows the controller to communicate with a PC or a networked computer system.

This product conforms to MODBUS RTU protocol a full description of which can be found on www.modbus.org.

Two ports are available both using MODBUS RTU communication facilities:

1. A configuration port - intended to communicate with a system to download the instrument parameters and to perform manufacturing tests and calibration
2. An optional EIA232 or EIA485 port on terminals HD, HE and HF - intended for field communications using, for example, a PC running a SCADA package.

The two interfaces cannot operate at the same time.

For a full description of digital communications protocols (Modbus RTU) refer to the 2000 series Communications Handbook, part number HA026230, available on www.eurotherm.co.uk.

Each parameter has its own unique Modbus address. A list of these is given at the end of this section.

15.1 Digital Communications Wiring

15.1.1 EIA232

To use EIA232 the PC will be equipped with an EIA232 port, usually referred to as COM 1.

To construct a cable for EIA232 operation use a three core screened cable.

The terminals used for EIA232 digital communications are listed in the table below. Some PC's use a 25 way connector although the 9 way is more common.

Standard Cable	PC socket pin no.		PC Function *	Instrument Terminal	Instrument Function
	9 way	25 way			
White	2	3	Receive, RX	HF	Transmit, TX
Black	3	2	Transmit, TX	HE	Receive, RX
Red	5	7	Common	HD	Common
Link together	1	6	Rec'd line sig. detect Data terminal ready Data set ready		
	4	8			
	6	11			
Link together	7	4	Request to send Clear to send		
	8	5			
Screen		1	Ground		

* These are the functions normally assigned to socket pins. Please check your PC manual to confirm.

15.1.2 EIA485 (2-wire)

To use EIA485, buffer the EIA232 port of the PC with a suitable EIA232/EIA485 converter. The Eurotherm Controls KD485 Communications Adapter unit is recommended for this purpose. The use of a EIA485 board built into the computer is not recommended since this board may not be isolated, which may cause noise problems, and the RX terminals may not be biased correctly for this application.

To construct a cable for EIA485 operation use a screened cable with one (EIA485) twisted pair plus a separate core for common. Although common or screen connections are not necessary, their use will significantly improve noise immunity.

The terminals used for EIA485 digital communications are listed in the table below.

Standard Cable Colour	PC Function *	Instrument Terminal	Instrument Function
White	Receive, RX+	HF (B) or (B+)	Transmit, TX
Red	Transmit, TX+	HE (A) or (A+)	Receive, RX
Green	Common	HD	Common
Screen	Ground		

- These are the functions normally assigned to socket pins. Please refer to your PC manual.

See section 2.16 for wiring diagrams

15.1.3 Wiring EIA422 or 4-wire EIA485

EIA422 is available as option 6XX in 3216 controllers only.

To use EIA422, buffer the EIA232 port of the PC with a suitable EIA232/EIA422 converter. The KD485 Communications Converter unit is recommended for this purpose. Instruments on a EIA422 communication network should be chain connected and not star connected.

To construct a cable for EIA422 operation use a screened cable with two twisted pairs plus a separate core for common. Although common or screen connections are not necessary, their use will significantly improve noise immunity.

The terminals used for EIA422 digital communications are listed in the table below.

Standard Cable Colour	PC socket pin no. 25 way	PC Function *	Instrument Terminal	Instrument Function
White	3	Receive (RX+)	HE	Transmit (TX+)
Black	16	Receive (RX-)	HF	Transmit (TX-)
Red	12	Transmit (TX+)	HB	Receive (RX+)
Black	13	Transmit (TX-)	HC	Receive (RX-)
Green	7	Common	HD	Common
Screen	1	Ground		

- * These are the functions normally assigned to socket pins. Please check your PC manual to confirm.



Warning. The 3200 series has a limited number of writes to EEPROM. Please ensure that parameters which do not require updating on a regular basis (for example, setpoints, alarm trip levels, hysteresis, etc) are only written to when a change in the parameter value occurs. Failure to do this could result in permanent damage to the internal EEPROM. See also section 15.3.

15.2 Digital Communications Parameters

The following table shows the parameters available.

DIGITAL COMMUNICATIONS LIST 'COMMS'						
Name	Scrolling Display	Parameter Description	Value		Default	Access Level
ID	MODULE IDENTITY	Comms identity	none	No module fitted	As order code	Conf L3 R/O
			r232	RS 232 Modbus interface		
			r485	EIA485 Modbus interface		
			r422	EIA422 Modbus 3216 only		
			dcP	Remote setpoint input. If fitted this ID replaces the above and no further parameters are shown		
ADDR	COMMUNICATIONS ADDRESS	Communications address of the instrument	1 to 254		1	L3
BAUD	COMMUNICATIONS BAUD RATE	Communications baud rate	1200	1200	9600	Conf L3 R/O
			2400	2400		
			4800	4800		
			9600	9600		
			19200	19,200		
PARITY	COMMUNICATIONS PARITY	Communications parity	none	No parity	none	Conf L3 R/O
			Even	Even parity		
			Odd	Odd parity		
DELAY	RX/TX DELAY TIME	To insert a delay between Rx and Tx to ensure that drivers have sufficient time to switch over.	OFF	No delay		Conf L3 R/O
			on	Fixed delay applied		
RETRAN	COMMS RETRANSMISSION	Master comms broadcast parameter. See section 15.2.1	none	None	none	
			w.SP	Working setpoint		
			PU	Process Variable		
			OP	Output demand		
			Err	Error		
REG.A	COMMS RETRANSMISSION ADDRESS	Parameter added in the Slave address to which the master communications value will be written See section 15.2.1.	0 to 9999		0	

15.2.1 Broadcast Communications

Broadcast communications as a simple master is available on 3200 controllers from software versions 1.10 or greater. Broadcast master communications allows the 3200 controller to send a single value to any number of slave instruments. Modbus broadcast using function code 6 (Write single value) must be used. This allows the 3200 to link with other products, without the need for a supervisory PC, to create a small system solution. Example applications include multi-zone setpoint programming applications or cascade control using a second controller. The facility provides a simple and precise alternative to analogue retransmission. The retransmitted parameter (address 12551) can be selected from Working Setpoint, Process Variable, Output Demand or Error. The controller will cease broadcast when it receives a valid request from a Modbus master - this allows iTools to be connected for commissioning purposes.

15.2.2 Broadcast Master Communications

The 3200 broadcast master can be connected to up to 31 slaves if no segment repeaters are used. If repeaters are used to provide additional segments, 32 slaves are permitted in each new segment. The master is configured by setting the 'RETRN' parameter to *w.SP*, *PL*, *OP* or *Err*.

Once the function has been enabled, the instrument will send this value out over the communications link every control cycle (250ms).

Notes:-

1. The parameter being broadcast must be set to the same decimal point resolution in both master and slave instruments.
2. If iTools, or any other Modbus master, is connected to the port on which the broadcast master is enabled, then the broadcast is temporarily inhibited. It will restart approximately 30 seconds after iTools is removed. This is to allow reconfiguration of the instrument using iTools even when broadcast master communications is operating.

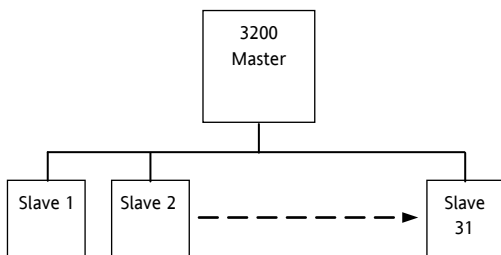

15.2.3 Wiring Connections

The Digital Communications module for use as a master or slave is fitted in Comms Module slot H and uses terminals HA to HF.

☺ EIA232

Rx connections in the master are wired to Tx connections of the slave

Tx connections in the master are wired to Rx connections of the slave

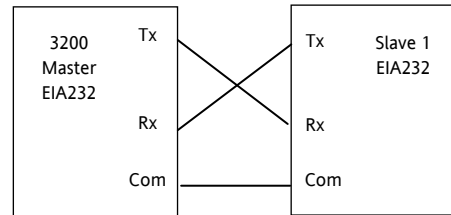

☺ EIA485 2-wire

Connect A (+) in the master to A (+) of the slave

Connect B (-) in the master to B (-) of the slave

This is shown diagrammatically below

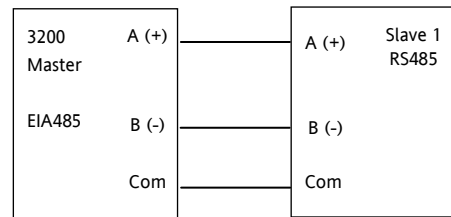

☺ EIA422 (4-wire) 3216 Only (option 6XX)

Rx connections in the master are wired to Tx connections of the slave

Tx connections in the master are wired to Rx connections of the slave

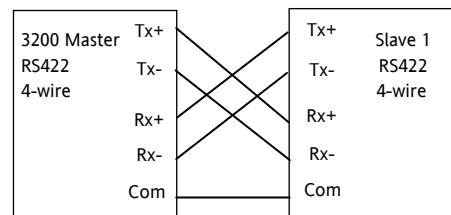

15.3 EEPROM Write Cycles



Warning

In common with most instruments in its class, the 3200 Range uses a non-volatile memory with a limited number of specified writes. Non-volatile memory is used to hold information that must be retained over a power cycle. Typically, this includes setpoint and status information, including alarm latch status.

Please ensure that parameters which do not require updating on a regular basis (for example, setpoints, alarm trip levels, hysteresis, etc) are only written to when a change in the parameter value occurs. Failure to do this could result in permanent damage to the internal EEPROM.

When using the 3200 range, use the 'AltSP' variable at Modbus address 26, which has no write restrictions, if you need to write to a temperature setpoint. A local trim value may also be applied using the 'SPTrim' parameter at Modbus address 27.

Some examples of parameters which could cause this limit to be exceeded over a period of time are given below.

Setpoint Ramping

Continuous changing of setpoint via digital communications – for example a ramping value – is the most common cause of EEPROM wear.

One solution, as stated above, is to enable the “Alternate Setpoint” (address 276), then write values directly to the “Alternate Setpoint, AltSP” (address 26). These parameters may be found in the SP list in iTools and are *L-R* and *REM.SP* in the controller. Note that an approximately 5 second timeout is applied to writes to Modbus address 26. This, therefore requires regular updating which, for setpoint ramping, is ideally suited.

In other applications where regular updating may not be ideal, this may be avoided by writing to the “Target Setpoint” at address 02. The Alternate Setpoint must also be enabled at address 276. The value written to address 02 will then be written permanently to address 26. Note, however, that any value written to the Target Setpoint will not be retained over a power fail since the controller then reverts to the setpoint selected (for example, SP1 or SP2).

It is **critically important** to select the Alternate Setpoint if updating the setpoint on a regular basis otherwise the setpoint change will be saved to non-volatile memory and EEPROM wear will result.

Alarms and other Status Changes

Alarm status is saved in non-volatile memory and this includes status alarms such as sensor break, loop break, remote fail and individual alarm and alarm latching status. Every transition into and out of an alarm condition triggers an EEPROM write. Thus, if there is any fast toggling of an alarm status, EEPROM wear can result within the expected lifetime of an instrument.

An example of this is where event alarms are used to provide an on/off control loop. 3200 instruments should on no account be used in this manner since the toggling of the output will rapidly use up the 100,000 writes. The On/Off control in the PID algorithm should be used instead. However, any situation where alarm states can change rapidly should be avoided.

Mode and Timer/Programmer Changes

Rapid changes to instrument mode (Auto/Manual) or the Timer/Programmer operation can cause EEPROM wear because the status (run/hold/reset) or the segment number are stored in EEPROM on each transition.







In normal use where segments or timer sequences are relatively long, it is unlikely that problems will be seen. However, in some applications where a sequence is run frequently, EEPROM wear will occur. An example of this is where a digital input is used in an application to trigger a timer sequence and the operation is performed as fast as possible by the operator.

Digital Inputs

Care should be taken with any rapid cycling digital inputs. Typically a digital input triggering timer or mode changes (as above) should be carefully considered so that they do not switch more than 100,000 times during the expected lifetime of the instrument.

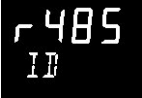
15.4 Example: To Set Up Instrument Address

This can be done in operator level 3:-

Do This	Display View	Additional Notes
1. Press  as many times as necessary to select 'COMMS LIST'		Scrolling display 'COMMS LIST'
2. Press  to scroll to 'ID'		Scrolling display 'ID'. This displays the type of communications board fitted
3. Press  to scroll to 'ADDR'		Up to 254 can be chosen but note that no more than 33 instruments should be connected to a single EIA232 link. Scrolling display 'ADDRESS'
4. Press  or  to select the address for this controller		

For further information see 2000 Series Communications Handbook Part No. HA026230.

15.5 DATA ENCODING

☺ Note that the Eurotherm iTools OPC server provides a straightforward means of accessing any variable in the 3200 controller in the correct data format without the need to consider data representation. However if you wish to write your own communications interface software, you will need to take the format used by the 3200 comms software into account.

Modbus data is normally encoded into a 16 bit signed integer representation.

Integer format data, including any value without a decimal point or represented by a textual value (for example 'off', or 'on'), is sent as a simple integer value.

For floating point data, the value is represented as a 'scaled integer', in which the value is sent as an integer which gives the result of the value multiplied by 10 to the power of the decimal resolution for that value. This is easiest to understand by reference to examples:

FP Value	Integer Representation
FP Value	Integer Representation
9.	9
-1.0	10
123.5	1235
9.99	999

It may be necessary for the Modbus master to insert or remove a decimal point when using these values.

It is possible to read floating point data in a native 32 bit IEEE format. This is described in the Eurotherm Series 2000 Communications Handbook (HA026230), Chapter 7.

For **time** data, for example, the length of a dwell, the integer representation depends on the resolution. For 'hours' resolution, the value returned is the number of minutes the value represents, so for example a value of 2:03 (2 hours and three minutes) would be returned as an integer value of 123. For 'minutes' resolution, the value used is the number of seconds the value represents, so that 12:09 (12 minutes and 9 seconds) would be returned as 729.

It is possible to read time data in a native 32 bit integer format, in which case it returns the number of milliseconds the variable represents regardless of the resolution. This is described in the Eurotherm Series 2000 Communications Handbook (HA026230), Chapter 7.

15.6 Parameter Modbus Addresses

Parameter Mnemonic	Parameter Name	Modbus Address Decimal
PV.IN	PV (Temperature) Input Value (see also Modbus address 203 which allows writes over Modbus to this variable).	1
TG.SP	Target Setpoint. NB – do not write continuously changing values to this variable. The memory technology used in this product has a limited (100,000) number of write cycles. If ramped setpoints are required, consider using the internal ramp rate function or the remote comms setpoint (Modbus address 26)in preference.	2
MAN.OP	Manual Output Value	3
WRK.OP	Working Output	4
WKG.SP	Working Setpoint (Read Only)	5
PB	Proportional Band	6
CTRL.A	Control Action 0 = Reverse Acting 1 = Direct Acting	7
Ti	Integral Time (0 = No Integral Action)	8
Td	Derivative Time (0 = No Derivative Action)	9
RNG.LO	Input Range Low Limit	11
RNG.HI	Input Range High Limit	12
A1.---	Alarm 1 Threshold	13
A2.---	Alarm 2 Threshold	14
SP.SEL	Active Setpoint Select 0 = Setpoint 1 1 = Setpoint 2	15
D.BAND	Channel 2 Deadband	16
CB.Lo	Cutback Low	17
CB.HI	Cutback High	18
R2G	Relative Cool/Ch2 Gain	19
MTR.T	Motor Travel Time	21
T.STAT	Timer Status 0 = Reset 1 = Run 2 = Hold 3 = End	23
SP1	Setpoint 1 NB – do not write continuously changing values to this variable. The memory technology used in this product has a limited (100,000) number of write cycles. If ramped setpoints are required, consider using the internal ramp rate function or the remote comms setpoint (Modbus address 26)in preference.	24
SP2	Setpoint 2 NB – do not write continuously changing values to this variable. The memory technology used in this product has a limited (100,000) number of write cycles. If ramped setpoints are required, consider using the internal ramp rate function or the remote comms setpoint (Modbus address 26)in preference.	25
Rm.SP	Remote (comms) setpoint. If selected using the remote setpoint selection (address 276 below, may also be controlled using the instrument HMI or a digital input) then this is used as a setpoint providing a value has been received within a window of about 5 seconds. If no value is received then the controller falls back to the currently selected setpoint (SP 1 or SP 2) with an error indication. The Remote Setpoint may have a local trim (SP Trim, address 27) added to it to compensate for variations in temperature in a particular zone. This parameter is not saved when the instrument is switched off. It may be written to continuously over communications without risk of damage to the instrument non-volatile memory.	26
LOC.t	Local Trim – added to the remote setpoint to compensate for local temperature variations in a control zone.	27
MR	Manual Reset	28
OP.HI	Output High Limit	30
OP.LO	Output Low Limit	31
SAFE	Safe Output Value for Sensor Break or other fault conditions.	34
SP.RAT	Setpoint Rate Limit Value (0 = no rate limit)	35
P.Err	Calculated Error (PV-SP)	39
A1.HYS	Alarm 1 Hysteresis	47
A2.HYS	Alarm 2 Hysteresis	68
A3.HYS	Alarm 3 Hysteresis	69

Parameter Mnemonic	Parameter Name	Modbus Address Decimal
A4.HYS	Alarm 4 Hysteresis	71
StAt	Instrument Status. This is a bitmap: B0 – Alarm 1 Status B1 – Alarm 2 Status B2 – Alarm 3 Status B3 – Alarm 4 Status B4 – Auto/Manual Status B5 – Sensor Break Status B6 – Loop Break Status B7 – CT Low load current alarm status B8 – CT High leakage current alarm status B9 – Program End B10 – PV Over-range (by > 5% of span) B11 – CT Overcurrent alarm status B12 – New Alarm Status B13 – Timer/Ramp Running B14 – Remote (comms) SP Fail B15 – Auto-tune Status In each case, a setting of 1 signifies 'Active', 0 signifies 'Inactive'.	75
-	Inverted Instrument Status. This is an inverted (bitwise) version of the preceding parameter and is provided so that scrolling messages can be triggered when a condition is not active. Bit mappings are as the "Instrument Status", Modbus address 75	76
LL.AMP	Load Leakage Current	79
LD.AMP	Load ON Current	80
A3.---	Alarm 3 Threshold	81
A4.---	Alarm 4 Threshold	82
LBT	Loop Break Time	83
F.OP	Forced manual output value	84
F.MOD	Forced manual output mode 0 – None 1 - Step 2 - Last	85
HYST.H	Ch1 On/Off Hysteresis in Eng Units	86
Di.IP	Digital Inputs Status. This is a bitmap: B0 – Logic input 1A B1 – Logic input LA B2 – Logic input LB B7 – Power has failed since last alarm acknowledge A value of 1 signifies the input is closed, otherwise it is zero. Values are undefined if options are not fitted or not configured as inputs.	87
HYST.C	Ch2 On/Off Hysteresis in Eng Units	88
FILT.T	Input Filter Time	101
RC.FT	Filter time constant for the rate of change alarm.	102
RC.PV	Calculated rate of change of the temperature or process variable in engineering units per minute.	103
Home	Home Display. 0 – Standard PV and SP display 1 – PV and Output Power display 2 – PV and Time remaining display 3 – PV and Timer elapsed time display 4 – PV and Alarm 1 setpoint 5 – PV and Load Current 6 – PV only 7 – PV and Composite SP/Time remaining 8 – Target setpoint 9 – No PV 10 – PV is not displayed when controller in Standby	106
-	Instrument version number. Should be read as a hexadecimal number, for example a value of 0111 hex is instrument V1.11	107
SP.HI	Setpoint High Limit	111
SP.LO	Setpoint Low Limit	112
-	Instrument type code.	122
ADDR	Instrument Comms Address	131

Parameter Mnemonic	Parameter Name	Modbus Address Decimal
PV.OFS	PV Offset	141
C.Adj	Calibration Adjust	146
IM	Instrument Mode 0 – Operating mode - all algorithms and I/O are active 1 – Standby - control outputs are off 2 – Config Mode - all outputs are inactive	199
MV.IN	Input value in millivolts	202
PV.CM	Comms PV Value. This may be used to write to the Process Variable (temperature) parameter over Modbus when a linearisation type of 'Comms' is selected, allowing the instrument to control to externally derived values. If sensor break is turned on, it is necessary to write to this variable once every 5 seconds. Otherwise a sensor break alarm will be triggered as a failsafe. If this is not required, turn sensor break off.	203
CJC.IN	CJC Temperature	215
SBR	Sensor Break Status (0 = Off, 1 = Active)	258
NEW.AL	New Alarm Status (0 = Off, 1 = Active)	260
LBR	Loop Break (0 = Off, 1 = Active)	263
A.TUNE	Auto-tune Enable (0 = Off, 1 = Enabled)	270
A-M	Mode of the Loop (0 = Auto, 1 = Manual)	273
Ac.All	Acknowledge all alarms (1 = Acknowledge)	274
L-R	Local Remote (Comms) Setpoint Select	276
	Remote setpoint in percent	277
REM.HI	Remote input high scalar – sets high range for setpoint input, corresponding to 20mA or 10V depending on the input type.	278
REM.LO	Remote input low scalar – sets low range for setpoint input, corresponding to 4mA or 0V depending on the input type.	279
ROP.HI	Sets the high range limit for the retransmitted setpoint. Allows a subset of the setpoint range to be retransmitted, and also allows the 3208/3204 setpoint range meter to display a range indication other than full scale. By default this is set to the setpoint high limit.	280
ROP.LO	Sets the low range limit for the retransmitted setpoint. Allows a subset of the setpoint range to be retransmitted, and also allows the 3208/3204 setpoint range meter to display a range indication other than full scale. By default this is set to the setpoint low limit.	281
A1.STS	Alarm 1 Status (0 = Off, 1 = Active)	294
A2.STS	Alarm 2 Status (0 = Off, 1 = Active)	295
A3.STS	Alarm 3 Status (0 = Off, 1 = Active)	296
A4.STS	Alarm 4 Status (0 = Off, 1 = Active)	297
LD.ALM	Low Load Current Threshold	304
LK.ALM	High Leakage Current Alarm (0 = Off, 1 = Active)	305
HC.ALM	Over Current Alarm Threshold	306
LOAD.A	Load Alarm Status (0 = Off, 1 = Active)	307
LEAK.A	Leak alarm Status.	308
HILC.A	Over Current alarm Status (0 = Off, 1 = Active)	309
REC.NO	Recipe to Recall	313
StOrE	Recipe to Save	314
TM.CFG	Timer type configuration 0 – No Timer 1 – Dwell Timer 2 – Delay Timer 3 – Soft Start Timer 10 – Programmer (Programmer Option only)	320
TM.RES	Timer Resolution 0 – Hours:Mins 1 – Mins:Secs	321
SS.SP	Soft Start Setpoint	322
SS.PWR	Soft Start Power Limit	323
DWELL	Requested Timer Duration	324
T.ELAP	Elapsed Time	325
T.REMN	Time Remaining	326
THRES	Timer Start threshold	327

Parameter Mnemonic	Parameter Name	Modbus Address Decimal
End.T	Timer End Type 0 – Off 1 – Dwell at current setpoint 2- Transfer to Setpoint 2 and dwell 3 – Reset programmer when the program ends	328
SERVO	'Servo' Mode (programmer option only) 0 – Start first ramp from current Working Setpoint. Program must be restarted after power failure 1 - Start first ramp from current PV (temperature). Program must be restarted after power failure 2 - Start first ramp from current Working Setpoint. Program will continue to run after power failure 3 - Start first ramp from current PV (temperature). Program must be restarted after power failure	329
EVENT	Event outputs	331
P.CYCL	Number of program cycles	332
CYCLE	Currently running program cycle	333
CTRL.H	Heat/Ch1 Control Type 0 – Off 1 – On/Off Control 2 – PID Control 3 – mtr Valve Position Control	512
CTRL.C	Cool/Ch2 Control Type 0 – Off 1 – On/Off Control 2 – PID Control	513
PB.UNT	Proportional Band Units 0 – Engineering Units 1 – Percent of Span	514
Lev2.P	Level 2 Code	515
UNITS	Display Units 0 – Degrees C 1 – Degrees F 2 – Kelvin 3 – None 4 – Percent	516
Lev3.P	Level 3 Code	517
Conf.P	Config Code	518
Cold	If set to 1 instrument will reset to factory defaults on next reset or power cycle.	519
PASS.C	Feature passcode C	520
PASS.2	Feature passcode 2	521
COOL.t	Cooling Algorithm Type: 0 – Linear 1 – Oil 2 – Water 3 – Fan	524
DEC.P	Decimal Point Position 0 – XXXX. 1 – XXX.X 2 – XX.XX	525
STBY.T	Standby Type 0 – Absolute Alarm Outputs Active – others off 1 – All outputs inactive	530
RAMP UNITS	0 – Ramp per Minute 1 – Ramp per Hour 2 – Ramp per Second	531
Meter	(3208/3204 Only). Ammeter configuration 0 – No ammeter 1 – Heat Output (0-100%) 2 – Cool Output (0-100% cooling) 3 – Working Setpoint (scaled within SP limits) 4 – PV (scaled within range) 5 – Output Power (scaled within Op Low and OP High limits) 6 – Output centered between –100% and 100% 7 – Error (PV-SP) (scaled between +/- 10 degrees) 8 – Instantaneous Amps (scaled 0 to CT Span)	532

Parameter Mnemonic	Parameter Name	Modbus Address Decimal
	9 – Load Current (scaled 0 to CT Span)	
uCAL	User Calibration Enable	533
A1.TYP	Alarm 1 Type 0 – Off 1 – Absolute High 2 – Absolute Low 3 – Deviation High 4 – Deviation Low 5 – Deviation Band	536
A2.TYP	Alarm 2 Type (as Alarm 1 Type)	537
A3.TYP	Alarm 3 Type (as Alarm 1 Type)	538
A4.TYP	Alarm 4 Type (as Alarm 1 Type)	539
A1.LAT	Alarm 1 Latching Mode 0 – No latching 1 – Latch - Automatic Reset 2 – Latch – Manual Reset	540
A2.LAT	Alarm 2 Latching Mode (as Alarm 1 Latching Mode)	541
A3.LAT	Alarm 3 Latching Mode (as Alarm 1 Latching Mode)	542
A4.LAT	Alarm 4 Latching Mode (as Alarm 1 Latching Mode)	543
A1.BLK	Alarm Blocking Mode Enable (0 = OFF, 1 = BLOCK)	544
A2.BLK	Alarm Blocking Mode Enable (0 = OFF, 1 = BLOCK)	545
A3.BLK	Alarm Blocking Mode Enable (0 = OFF, 1 = BLOCK)	546
A4.BLK	Alarm Blocking Mode Enable (0 = OFF, 1 = BLOCK)	547
Di.OP	Digital Outputs Status. This is a bitmap: B0 – Output 1A B1 – Output 2A B2 – Output 3 on 32h8 and 3208 controllers B3 – Output 4/AA It is possible to write to this status word to use the digital outputs in a telemetry output mode. Only outputs whose function is set to 'none' are affected, and the setting of any bits in the Digital Output Status word will not affect outputs used for heat (for example) or other functions. Thus it is not necessary to mask in the settings of these bits when writing to this variable.	551
OFS.HI	Adjust High Offset	560
OFS.LO	Adjust Low Offset	561
PNT.HI	Adjust High Point	562
PNT.LO	Adjust Low Point	563
CT.RNG	CT Range	572
Sb.tyP	Sensor Break Type 0 – No Sensor Break 1 – Non-Latching Sensor Break 2 – Latching Sensor Break	578
Id	Customer ID – May be set to any value between 0-9999 for identification of instruments in applications. Not used by the instrument itself.	629
PHASE	Calibration Phase 0 – None 1 – 0 mv 2 – 50 mv 3 – 150 Ohm 4 – 400 Ohm 5 – CJC 6 – CT 0 mA 7 – CT 70 mA 8 – Factory Defaults 9 – Output 1 mA low cal 10 – Output 1 mA high cal 11 – Output 2 mA low cal	768

Parameter Mnemonic	Parameter Name	Modbus Address Decimal
	12 – Output 2 mA high cal 13 – Output 3 ma low cal (3208/3204 only) 14 – Output 3 ma high cal (3208/3204 only) 15 – Remote setpoint input low volts 16 – Remote setpoint input high volts 17 – Remote setpoint input low current 18 – Remote setpoint input high current	
GO	Calibration Start 0 – No 1 – Yes (start cal) 2 – Cal Busy 3 – Cal Pass 4 – Cal Fail Note values 2-4 cannot be written but are status returns only	769
-	Analogue Output Calibration Value	775
K.LOC	Allows instrument to be locked via a key/digital input 0 - unlocked, 1 – all keys locked 2 – Edit keys (raise and lower) disabled 3 – Mode key disabled 4 – Manual mode disabled 5 – Enter standby mode when Mode combination pressed 6 – Timer keys disabled	1104
Dwel.1	Programmer Dwell 1 Duration	1280
TSP.1	Programmer Target Setpoint 1	1281
RMP.1	Programmer Ramp Rate 1	1282
Dwel.2	Programmer Dwell 2 Duration	1283
TSP.2	Programmer Target Setpoint 2	1284
RMP.2	Programmer Ramp Rate 2	1285
Dwel.3	Programmer Dwell 3 Duration	1286
TSP.3	Programmer Target Setpoint 3	1287
RMP.3	Programmer Ramp Rate 3	1288
Dwel.4	Programmer Dwell 4 Duration	1289
TSP.4	Programmer Target Setpoint 4	1290
RMP.4	Programmer Ramp Rate 4	1291
AT.R2G	Auto-tune Configures R2G 0 - YES 1 - No	4176
IN.TYP	Input Sensor Type 0 – J Type Thermocouple 1 – K Type Thermocouple 2 – L Type Thermocouple 3 – R Type Thermocouple 4 – B Type Thermocouple 5 – N Type Thermocouple 6 – T Type Thermocouple 7 – S Type Thermocouple 8 – RTD 9 – millivolt 10 – Comms Input (see Modbus address 203) 11 – Custom Input (Downloadable)	12290
CJ.tyP	CJC Type 0 – Auto 1 – 0 Degrees C 2- 50 Degrees C	12291
mV.HI	Linear Input High	12306
mV.LO	Linear Input Low	12307
L.TYPE	Logic Input A channel hardware type 0 – None 1 – Logic Inputs	12352
L.D.IN	Logic input A function	12353

Parameter Mnemonic	Parameter Name	Modbus Address Decimal
	40 – None 41 – Acknowledge all alarms 42 – Select SP1/2 43 – Lock All Keys 44 – Timer Reset 45 – Timer Run 46 – Timer Run/Reset 47 – Timer Hold 48 – Auto/Manual Select 49 – Standby Select 50 – Remote setpoint 51 – Recipe select through IO1 52 – Remote key UP 53 – Remote key DOWN	
L.SENS	Configures the polarity of the logic input channel A (0 = Normal, 1 = Inverted)	12361
L.TYPE (LB)	Logic Input B channel hardware type (3208/3204 only) 0 – None 1 – Logic Inputs	12368
L.D.IN (LB)	Logic input B function (3208/3204 only) 40 – None 41 – Acknowledge all alarms 42 – Select SP1/2 43 – Lock All Keys 44 – Timer Reset 45 – Timer Run 46 – Timer Run/Reset 47 – Timer Hold 48 – Auto/Manual Select 49 – Standby Select 50 – Remote setpoint 51 – Recipe select through IO1 52 – Remote key UP 53 – Remote key DOWN	12369
L.SENS (LB)	Configures the polarity of the logic input channel B (0 = Normal, 1 = Inverted) (3208/4 only)	12377
ID	Comms Module Type 0 – None 1 – EIA232 2 – EIA232 3 – EIA232 4 – Remote setpoint input	12544
BAUD	Baud Rate 0 – 9600 1 – 19200 2 – 4800 3 – 2400 4 – 1200	12548
PRTY	Parity setting 0 – None 1 – Even 2 – Odd	12549
DELAY	RX/TX Delay – (0 = no delay, 1 = delay) Select if a delay is required between received and transmitted comms messages. Sometimes required when intelligent EIA232 adaptors are used.	12550
RETRN	Comms Retransmission Variable selection: 0 – Off 1 – Working Setpoint 2 – PV 3 – Output Power 4 – Error	12551
REG.AD	Modbus register address to broadcast retransmission to. For example if you wish to retransmit the working setpoint from one 3200 to a group of slaves, and receive the master working setpoint into the slaves' remote setpoint, set this variable to 26 (the address of the remote setpoint in the slave units).	12552
Ct.Id	Current Transformer	12608
CT.SRC	CT Source 0 – None	12609

Parameter Mnemonic	Parameter Name	Modbus Address Decimal
	1 – IO1 2 – OP2 8 – AA (OP4)	
CT.LAT	CT Alarm Latch Type 0 – No latching 1 – Latch – Automatic Reset 2 – Latch – Manual Reset	12610
1.ID	IO channel 1 hardware type 0 – None 1 – Relay 2 – Logic I/O 3 – DC OP 4 – Triac (SSR)	12672
1.D.IN	IO1 Digital input function Logic input function 40 – None 41 – Acknowledge all alarms 42 – Select SP1/2 43 – Lock All Keys 44 – Timer Reset 45 – Timer Run 46 – Timer Run/Reset 47 – Timer Hold 48 – Auto/Manual Select 49 – Standby Select 50 – Remote setpoint 51 – Recipe select through IO1 52 – Remote key UP 53 – Remote key DOWN	12673
1.Func	I/O Channel Function 0 – None (or Telemetry Output) 1 – Digital Output 2 – Heat or UP if valve position 3 – Cool or DOWN if valve position 4 – Digital Input 10 – DC Output no function 11 – DC Output Heat 12 – DC Output Cool 13 – DC Output WSP retransmission 14 – DC Output PV retransmission 15 – DC Output OP retransmission	12675
1.RNG	IO Channel 1 DC Output Range 0 – 0-20mA 1 – 4-20mA	12676
1.SRC.A	IO Channel 1 Source A 0 – None 1 – Alarm 1 2 – Alarm 2 3 – Alarm 3 4 – Alarm 4 5 – All Alarms (1-4) 6 – New Alarm 7 – CT Alarm (Load, Leak or Overcurrent) 8 – Loop Break Alarm 9 – Sensor Break Alarm 10 – Timer End (or Not Ramping) 11 – Timer Run (or Ramping) 12 – Auto/Manual 13 – Remote fail 14 – Power fail 15 – Programmer event	12678
1.SRC.B	IO Channel 1 Source B As IO Channel 1 Source A (Modbus address 12678)	12679
1.SRC.C	IO Channel 1 Source C As IO Channel 1 Source A (Modbus address 12678)	12680

Parameter Mnemonic	Parameter Name	Modbus Address Decimal
1.SRC.D	IO Channel 1 Source D As IO Channel 1 Source A (Modbus address 12678)	12681
1.SENS	Configures the polarity of the input or output channel (0 = Normal, 1 = Inverted)	12682
1.PLS	IO1 Time proportioning Output minimum pulse time	12706
2.ID	Output 2 Type 0 – None 1 – Relay 2 – Logic Output 3 – DC OP 4 – Triac (SSR)	12736
2.FUNC	Output 2 Channel function 0 – None (or Telemetry Output) 1 – Digital Output 2 – Heat or UP if valve position 3 – Cool or DOWN if valve position 10 – DC Output no function 11 – DC Output Heat 12 – DC Output Cool 13 – DC Output WSP retransmission 14 – DC Output PV retransmission 15 – DC Output OP retransmission	12739
2.RNG	IO Channel 2 DC Output Range 0 – 0-20mA 1 – 4-20mA	12740
2.SRC.A	Output 2 source A As IO Channel 1 Source A (Modbus address 12678)	12742
2.SRC.B	Output 2 source B As IO Channel 1 Source A (Modbus address 12678)	12743
2.SRC.C	Output 2 source C As IO Channel 1 Source A (Modbus address 12678)	12744
2.SRC.D	Output 2 source D As IO Channel 1 Source A (Modbus address 12678)	12745
2.SENS	Output 2 Polarity (0 = Normal, 1 = Inverted)	12746
2.PLS	Output 2 Time proportioning Output minimum pulse time	12770
3.ID	Output 3 Type 0 – None 1 – Relay 2 – 3 – DC OP	12800
3.FUNC	Output 3 Channel function 0 – None (or Telemetry Output) 1 – Digital Output 2 – Heat or UP if valve position 3 – Cool or DOWN if valve position 10 – DC Output no function 11 – DC Output Heat 12 – DC Output Cool 13 – DC Output WSP retransmission 14 – DC Output PV retransmission 15 – DC Output OP retransmission	12803
3.RNG	IO Channel 3 DC Output Range 0 – 0-20mA 1 – 4-20mA	12804
3.SRC.A	Output 3 source A As IO Channel 1 Source A (Modbus address 12678)	12806
3.SRC.B	Output 3 source B As IO Channel 1 Source A (Modbus address 12678)	12807
3.SRC.C	Output 3 source C As IO Channel 1 Source A (Modbus address 12678)	12808
3.SRC.D	Output 3 source D As IO Channel 1 Source A (Modbus address 12678)	12809
3.SENS	Output 3 Polarity (0 = Normal, 1 = Inverted)	12810
3.PLS	Output 3 Time proportioning Output minimum pulse time	12834

Parameter Mnemonic	Parameter Name	Modbus Address Decimal
4.TYPE	Output AA Type 0 – None 1 – Relay	13056
4.FUNC	Output 4 Channel function 0 – None (or Telemetry Output) 1 – Digital Output 2 – Heat or UP if valve position 3 – Cool or DOWN if valve position	13059
4.SRC.A	Output AA source A As IO Channel 1 Source A (Modbus address 12678)	13062
4.SRC.B	Output AA source B As IO Channel 1 Source A (Modbus address 12678)	13063
4.SRC.C	Output AA source C As IO Channel 1 Source A (Modbus address 12678)	13064
4.SRC.D	Output AA source D As IO Channel 1 Source A (Modbus address 12678)	13065
4.SENS	Output Polarity (0 = Normal, 1 = Inverted)	13066
4.PLS	Output AA Time proportioning Output minimum pulse time	13090

16. Calibration

The controller is calibrated during manufacture using traceable standards for every input range. It is, therefore, not necessary to calibrate the controller when changing ranges. Furthermore, the use of a continuous automatic zero correction of the input ensures that the calibration of the instrument is optimised during normal operation.

To comply with statutory procedures such as the Heat Treatment Specification AMS2750, the calibration of the instrument can be verified and re-calibrated if considered necessary in accordance with the instructions given in this chapter.

For example AMS2750 states:- "Instructions for calibration and recalibration of "field test instrumentation" and "control monitoring and recording instrumentation" as defined by the NADCAP Aerospace Material Specification for pyrometry AMS2750D clause 3.2.5 (3.2.5.3 and sub clauses), including Instruction for the application and removal of offsets defined in clause 3.2.4."

16.1 To Check Input Calibration

The PV Input may be configured as mV, mA, thermocouple or platinum resistance thermometer.

16.1.1 Precautions

Before checking or starting any calibration procedure the following precautions should be taken:-

1. When calibrating mV inputs make sure that the calibrating source output is set to less than 250mV before connecting it to the mV terminals. If accidentally a large potential is applied (even for less than 1 second), then at least one hour should elapse before commencing the calibration.
2. RTD and CJC calibration must not be carried out without prior mV calibration.
3. A pre-wired jig built using a spare instrument sleeve may help to speed up the calibration procedure especially if a number of instruments are to be calibrated.
4. Power should be turned on only after the controller has been inserted in the sleeve of the pre-wired circuit. Power should also be turned off before removing the controller from its sleeve.
5. Allow at least 10 minutes for the controller to warm up after switch on.

16.1.2 To Check mV Input Calibration

The input may have been configured for a process input of mV, Volts or mA and scaled in Level 3 as described in section 8.3. The example described in section 8.3.1 assumes that the display is set up to read 2.0 for an input of 4.000mV and 500.0 for an input of 20.000mV.

To check this scaling, connect a milli-volt source, traceable to national standards, to terminals V+ and V- using copper cable as shown in the diagram below.

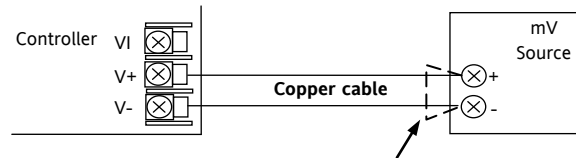

Figure 1: Connections for mV Input Calibration

☺ Ensure that no offsets (see sections 8.2.1 and 16.2) have been set in the controller.

Set the mV source to 4.000mV. Check the display reads $2.0 \pm 0.25\% \pm 1\text{LSD}$ (least significant digit).

Set the mV source to 20.000mV. Check the display reads $500.0 \pm 0.25\% \pm 1\text{LSD}$.

16.1.3 To Check Thermocouple Input Calibration

Connect a milli-volt source, traceable to national standards, to terminals V+ and V- as shown in the diagram below. The mV source must be capable of simulating the thermocouple cold junction temperature. It must be connected to the instrument using the correct type of thermocouple compensating cable for the thermocouple in use.

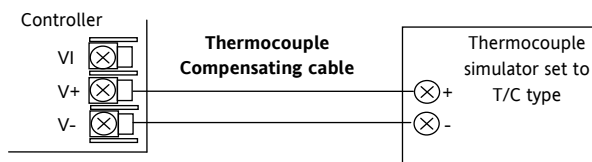

Figure -2: Connections for Thermocouple Calibration

Set the mV source to the same thermocouple type as that configured in the controller.

Adjust the mV source for to the minimum range. For a type J thermocouple, for example, the minimum range is -210°C . However, if it has been restricted using the Range Low parameter then set the mV source to this limit. Check that the reading on the display is within $\pm 0.25\%$ of reading $\pm 1\text{LSD}$.

Adjust the mV source for to the maximum range. For a type J thermocouple, for example, the minimum range is 1200°C . However, if it has been restricted using the Range High parameter then set the mV source to this limit. Check that the reading on the display is within $\pm 0.25\%$ of reading $\pm 1\text{LSD}$.

Intermediate points may be similarly checked if required.

16.1.4 To Check RTD Input Calibration

Connect a decade box with total resistance lower than 1K and resolution to two decimal places in place of the RTD as indicated on the connection diagram below **before the instrument is powered up**. If at any instant the instrument was powered up without this connection then at least 10 minutes must elapse from the time of restoring this connection before RTD calibration check can take place.

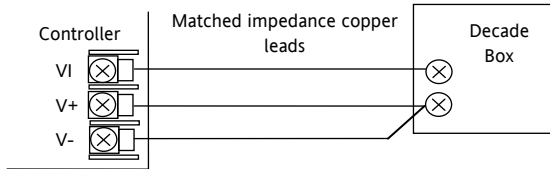

Figure -3: Connections for RTD Calibration

The RTD range of the instrument is -200 to 850°C. It is, however, unlikely that it will be necessary to check the instrument over this full range.

Set the resistance of the decade box to the minimum range. For example 0°C = 100.00Ω. Check the calibration is within ±0.25% of reading ± 1LSD.
 Set the resistance of the decade box to the maximum range. For example 200°C = 175.86Ω. Check the calibration is within ±0.25% of reading ± 1LSD.

16.2 Offsets

The process value can be offset to take into account known errors within the process. The offset can be applied to any Input Type (mV, V, mA, thermocouple or RTD).

A single offset can be applied - the procedure is carried out in the **INPUT** list and has been described in section 8.2.

It is also possible to adjust the low and high points as a two point offset. This can only be done in **Level 3** in the '**CAL**' list and is described below.

16.2.1 Two Point Offset

A two point offset adjusts both a low point and a high point and applies a straight line between them. Any readings above and below the calibration points will be an extension of this straight line. For this reason it is best to calibrate with the two points as far apart as possible as shown in the example below:-

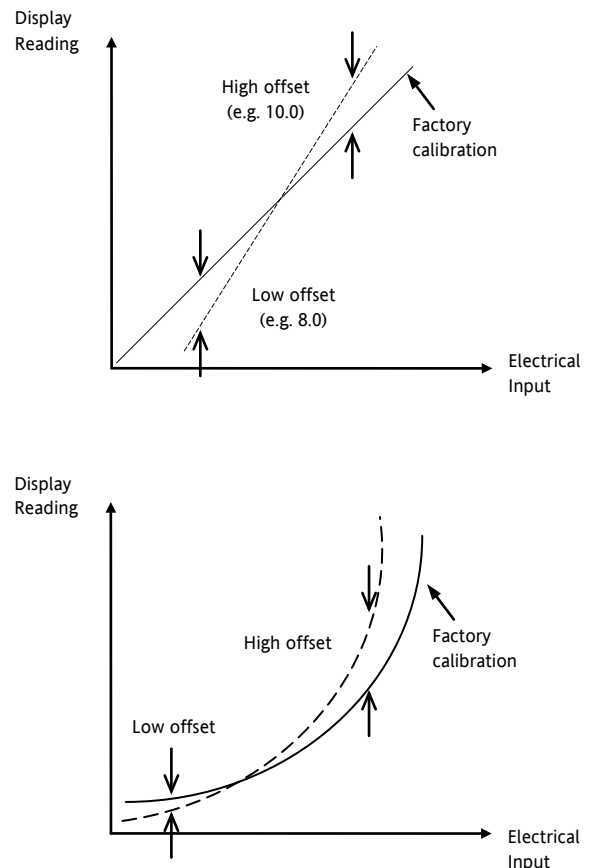









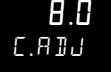













Figure 4 Two Point Offset Applied to Linear and Non-linear Inputs







16.2.2 To Apply a Two Point Offset

Assume the instrument is set up (as described in section 8.3.1) to display 0.0 for an input of 4.00mV and 500.0 for an input of 20.00mV. Assume that a particular sensor in use has known errors such that the instrument is required to read 8.0 for an input of 4.00mV and 490.0 for an input of 20.00mV. To compensate for these errors in the process a low point offset of 8.0 and a high point offset of 10.0 can be set as follows:-

Operation	Do This	Display View	Additional Notes
Select Calibration list header	1. Select Level 3 as described in section 6.1.3. Then press  to select 'CAL'		Two point offset can only be carried out in Level 3
Set mV input to 4.00mV			
Select User Calibration	2. Press  to scroll to 'U.CAL'		Scrolling 2message <i>USER CALIBRATION</i>
Select Low calibration point	3. Press  or  to 'LO'		
Set the low offset value	4. Press  to scroll to 'C.ADJ' 5. Press  or  to set the low offset value eg 8.0		This applies an offset over the whole range in the same way as a simple offset section 8.2.
	6. The controller then reverts to the CAL list header		This is the same as 1 above
Set mV input to 20.00mV			
Select User Calibration	7. Press  to scroll to 'U.CAL'		This is the same as 2 above
Select the high calibration point	8. Press  or  to 'HI'		
Select the high calibration offset parameter	9. Press  to scroll to 'C.ADJ'		The reading will show 508.0
Set the high offset value	10. Press  or  to set the high offset value to read 490.0		

Under normal operating conditions the controller will now read 8.0 for an input of 4.000mV and 490.0 for an input of 20.000mV.

16.2.3 To Remove the Two Point Offset

Operation	Do This	Display View	Additional Notes
In level 3 select the Calibration list header	1. In Level 3 , press  to select 'CAL'		Two point offset can only be carried out in Level 3
Select User Calibration	2. Press  to scroll to 'U.CAL'		Scrolling message <i>USER CALIBRATION</i>
Reset to no offset	3. Press  or  to select 'r.SET'		

The display will revert to 2 above and the two point offsets will be removed.

16.3 Input Calibration

If the calibration is not within the specified accuracy follow the procedures in this section:-

In 3200 series instruments, inputs which can be calibrated are:-

- **mV Input.** This is a linear 80mV range calibrated at two fixed points. This should always be done before calibrating either thermocouple or resistance thermometer inputs. mA range calibration is included in the mV range.
- **Thermocouple** calibration involves calibrating the temperature offset of the CJC sensor only. Other aspects of thermocouple calibration are also included in mV calibration.
- **Resistance Thermometer.** This is also carried out at two fixed points - 150Ω and 400Ω.

















16.3.1 To Calibrate mV Input

Calibration can only be carried out in configuration level.

Calibration of the mV range is carried out using a 50 milli-volt source, connected as described in section 16.1.2. mA calibration is included in this procedure.











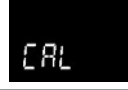

For best results 0mV should be calibrated by disconnecting the copper wires from the mV source and short circuiting the input to the controller

To calibrate the mV Input, select **Conf Level** as described in section 6.1.3, set the controller input to mV range, then:-

Operation	Do This	Display View	Additional Notes
Select the Calibration List header	1. From any display press  as many times as necessary until the 'CAL' page header is displayed.		Scrolling display 'CALIBRATION LIST'
Select the Calibration Phase	2. Press  to select 'PHASE'		Scrolling display 'CALIBRATION PHASE'
Set mV source for 0mV			
Select the low calibration point	3. Press  or  to choose '0'		
Calibrate the instrument to the low calibration point (0mV)	4. Press  to select 'GO' 5. Press  or  to choose 'YES'	  	Scrolling display 'CALIBRATION START' The controller automatically calibrates to the injected input mV. The display will show <i>busy</i> then <i>PASS</i> , (if calibration is successful.) or <i>FAIL</i> if not. Fail may be due to incorrect input mV
Set mV source for 50mV			
Select the high calibration point	6. Press  to select 'PHASE' 7. Press  or  to choose '50' 8. Repeat 5 and 6 above to calibrate the high point		The controller will again automatically calibrate to the injected input mV. If it is not successful then <i>FAIL</i> will be displayed

16.3.2 To Calibrate Thermocouple Input

Thermocouples are calibrated, firstly, by following the previous procedure for the mV ranges, then calibrating the CJC. Connect a mV source as described in section 16.1.3. Set the mV source to 'internal compensation' for the thermocouple in use and set the output for **0mV**. Then:-

















Operation	Do This	Display View	Additional Notes
Select the Calibration List header	1. From any display press  as many times as necessary until the 'CAL' page header is displayed.		
Select the calibration phase	2. Press  to select 'PHASE'		Scrolling display 'CALIBRATION PHASE'
Select CJC calibration	3. Press  or  to select 'CJC'		
Calibrate CJC	4. Press  to select 'GO' 5. Press  or  to choose 'YES'	  	The controller automatically calibrates to the CJC input at 0mV. The display will show <i>busy</i> then <i>PASS</i> , (if calibration is successful) or 'FAIL' if not. Fail may be due to an incorrect input mV

16.3.3 To Calibrate RTD Input

The two points at which the RTD range is calibrated are 150.00Ω and 400.00Ω.

Before starting RTD calibration:

- A decade box with total resistance lower than 1K must be connected in place of the RTD as indicated on the connection diagram in section 16.1.4 **before the instrument is powered up**. If at any time the instrument was powered up without this connection then at least 10 minutes must elapse from the time of restoring this connection before RTD calibration can take place.
- The instrument should be powered up for at least 10 minutes.
- Before calibrating the RTD input the mV range must be calibrated first

Operation	Do This	Display View	Additional Notes
Select the Calibration List header	1. From any display press  as many times as necessary until the 'CAL' page header is displayed.		Scrolling display 'CALIBRATION LIST'
Select the calibration phase	2. Press  to select 'PHASE'		Scrolling display 'CALIBRATION PHASE'
Set the decade box for 150.00Ω			
Select the low calibration point (150Ω)	3. Press  or  to choose '150r'		
Calibrate the low point	4. Press  to select 'GO' 5. Press  or  to choose 'YES'	  	Scrolling display 'CALIBRATION START'
The controller automatically calibrates to the injected 150.00Ω input. The display will show <i>bUSY</i> then <i>PASS</i> (if calibration is successful) or <i>'FAIL'</i> if not. Fail may be due to an incorrect input resistance			
Set the decade box for 400.00Ω			
Select the high calibration point (400Ω)	7. Press  or  to choose '400r'		
Calibrate the high point	8. Repeat 5 and 6 above to calibrate the high point		
The controller will again automatically calibrate to the injected 400.00Ω input. If it is not successful then <i>'FAIL'</i> will be displayed			

16.3.4 To Calibrate mA Outputs

I/O1, Output 2 and/or Output 3 may be supplied as mA outputs. The outputs may be adjusted as follows:-
Connect an ammeter to the output – terminals 1A/1B, 2A/2B or 3A/3B as appropriate.

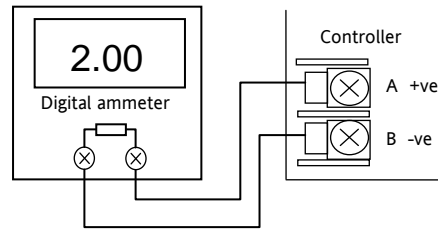

Then, in configuration level:-

Operation	Do This	Display View	Additional Notes
Select low point calibration phase for the mA output to be calibrated (eg OP1)	<ol style="list-style-type: none"> From the 'CAL' list header press to select 'PHASE' Press or to choose '1mA' 		Scrolling message 'CALIBRATION PHASE'
Set the low point output	<ol style="list-style-type: none"> Press to select 'VALUE' Press or to adjust this value so that it reads the same value as shown on the ammeter. For example if the meter reads 2.06 then set the controller reading for 206. The decimal point is not displayed on the controller so that 200 represents 2.00. 		Scrolling message 'DC OUTPUT READING'
Select high point calibration phase for the mA output to be calibrated (eg OP1)	<ol style="list-style-type: none"> Press to go back to 'PHASE' Press or to choose '1mA' 		Scrolling message 'CALIBRATION PHASE'
Set the high point output	<ol style="list-style-type: none"> Press to select 'VALUE' Press or to adjust this value so that it reads the same value as shown on the ammeter. The value represents 18.00mA 		Scrolling message 'DC OUTPUT READING'

The above procedure may be repeated for outputs 2 and 3 if they are fitted with analogue output modules.

16.3.5 To Calibrate Remote Setpoint Input

Connect a milli amp source to terminals HD and HE as shown.

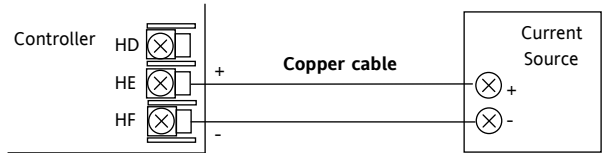

Select **Conf Level** as described in section 6.1.3, then:-

Operation	Do This	Display View	Additional Notes
Select the Calibration List header	1. From any display press as many times as necessary until the 'CAL' page header is displayed.		Scrolling display 'CALIBRATION LIST'
Select the Calibration Phase	2. Press to select 'PHASE'		Scrolling display 'CALIBRATION PHASE'
Set mA source for 4mA			
Select the low calibration point	3. Press or to choose 'rmLL'		
Calibrate the instrument to the low calibration point (4mA)	4. Press to select 'GO' 5. Press or to choose 'YES'	 	Scrolling display 'CALIBRATION START' The controller automatically calibrates to the injected input. The display will show <i>busy</i> then <i>PASS</i> , (if calibration is successful) or <i>FAIL</i> if not. Fail may be due to incorrect input. mA
Set mV source for 20mA			
Select the high calibration point	9. Press to select 'PHASE' 10. Press or to choose 'rmEH' 11. Repeat 4 and 5 above to calibrate the high point		The controller will again automatically calibrate to the injected input mV. If it is not successful then 'FAIL' will be displayed

To calibrate the voltage input, connect a volts source to terminals HD (negative) and HF (positive). The procedure is the same as described above but the calibration points are:-

Parameter	Calibration Voltage
rmLL	0 Volts
rmEH	10 Volts

16.3.6 CT Calibration

To calibrate the current transformer input, connect the current transformer to terminals CT and C.

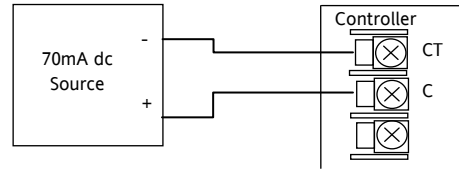

Then in configuration level

Operation	Do This	Display View	Additional Notes
Select the current transformer low point calibration phase	1. From the 'CAL' list header press to select 'PHASE' 2. Press or to choose 'CT 0'		Scrolling display 'CALIBRATION PHASE'
Adjust the CT for no current applied to the input			
Calibrate the CT low point	3. Press to select 'GO' 4. Press or to 'YES'	 	Scrolling display 'CALIBRATION START'
The controller automatically calibrates to the zero current input. As it does this the display will show <i>busy</i> then <i>PASS</i> , assuming a successful calibration. If it is not successful then <i>FAIL</i> will be displayed. This may be due to an incorrect input current			
Select the current transformer high point calibration phase	6. Press or to choose 'CT 70'		
Adjust the CT for a current of 70mA dc			
	7. Press to select 'GO' 8. Press or to 'YES'	 	The controller again automatically calibrates to 70mA If it is not successful then <i>FAIL</i> will be displayed

16.3.7 To Return to Factory Calibration

It is always possible to revert to the factory calibration as follows:-

Operation	Do This	Display View	Additional Notes
Select the calibration phase	1. From the 'CAL' list header press to select 'PHASE'		
Select factory calibration values	2. Press or to choose 'FACT'		
Confirm	3. Press to select 'GO' 4. Press or to choose 'YES'	 	The controller automatically returns to the factory values stored during manufacture

16.4 Calibration Parameters

The following table gives the parameters available in the Calibration List.

The User Calibration is available in Level 3 only and is used to calibrate 'Offset' see section 8.2.

CALIBRATION PARAMETER LIST			'CAL'			
Name	Scrolling Display	Parameter Description	Value		Default	Access Level
UCAL	USER CALIBRATION	To select low and high offset state or reset to no offsets. See section 16.2.2.	Idle	Normal operating state	Idle	L3 only
			Lo	Low offset		
			Hi	High offset		
			Reset	Remove high and low offsets		
The following parameters appear when calibrating the controller ie UCAL = Lo or Hi						
CAL ADJUST	CALIBRATION ADJUST	To set an offset value. See section 16.2.2.	-1999 to 9999			L3 only

Input and Output calibration can only be done in Conf level.

CALIBRATION PARAMETER LIST			'CAL'			
Name	Scrolling Display	Parameter Description	Value	Default	Access Level	
PHASE	CAL PHASE	To calibrate low and high offset	none	Not selected	none	Conf only
			0	Select mV low calibration point		
			50	Select mV high calibration point		
			150r	Select PRT low cal point		
			400r	Select PRT high cal point		
			CJC	Select CJC calibration		
			CT 0	Select CT low cal point		
			CT 70	Select CT high cal point		
			FACT	Return to factory settings		
			1mA L	Low mA output from I/O 1		
			1mA H	High mA output from I/O 1		
			2mA L	Low mA output from output 2		
			2mA H	High mA output from output 2		
			3mA L	Low mA output from output 3		
			3mA H	High mA output from output 3		
			rmVL	Remote setpoint input low volts		
rmVH	Remote setpoint input high volts					
rmCL	Remote setpoint input low current					
rmCH	Remote setpoint input high current					
GO		To start the calibration sequence	NO		NO	Conf only
			YES	Start		
			bUSY	Calibrating		
			PASS	Calibration successful		
			FAIL	Calibration unsuccessful		

17. Configuration Using iTools

iTools is a configuration and monitoring package which will edit, store and 'clone' complete controller configurations.

iTools can be used to configure all the functions of 3200 series controllers described in this manual. It is also possible using iTools to configure additional functions such as customised messages and parameter promotion. These features are described in this chapter.

You may also wish to refer to the iTools Help Manual Part No. HA028838. This can be downloaded from www.eurotherm.co.uk. A provides further information on how to install, connect and generally operate iTools.

17.1 Loading an IDM

An IDM is a software file which defines the parameter addresses of a particular build of instrument. This is normally included with your iTools CD and iTools will then recognize the software version of your instrument. Alternatively, download the latest version of iTools. This may be found in www.eurotherm.co.uk.

If the build of your instrument is a non-standard, it may be necessary for you to download the IDM from the Eurotherm web site. The file will be of the format id32i_v107.exe, where id 32i is the instrument and V--- is the software version number of the instrument.

To load the IDM

From windows START, select Programs → Eurotherm iTools → Advanced Tools → IDM Manager. Then Install New IDM.

To register the new IDM

Copy the file to c:\Program Files\Eurotherm\iTools\Devices.

17.2 Connecting a PC to the Controller

In 3200 series controllers this may be done using digital communications port H or by a configuration clip.

17.2.1 Using the H Communications Port

Connect the controller to the EIA232 serial comms port of the PC shown in the diagram below.

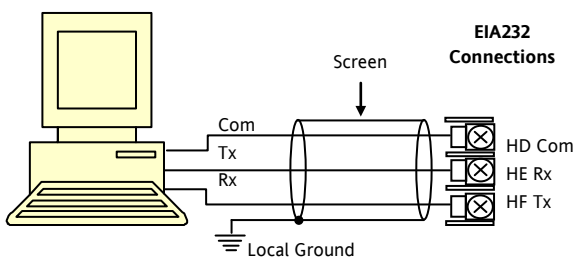

17.2.2 Configuration Clip

A Configuration Clip is available with iTools by quoting part number 3000CK in the iTools ordering code. The clip can be fitted into the side of a controller as shown below.

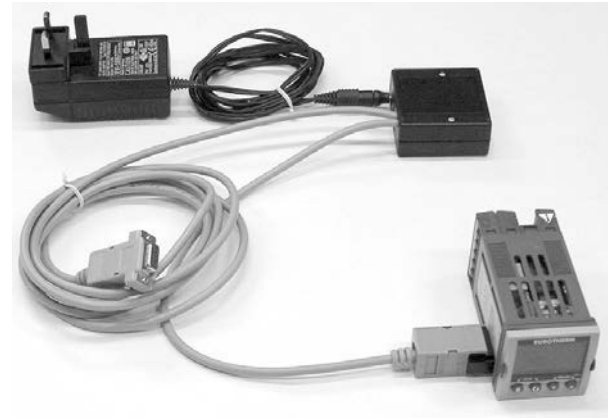

The benefit of using this arrangement is that it is not necessary to power the controller, since the clip provides the power to the internal memory of the controller.

17.3 Starting iTools

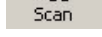
Open iTools and, with the controller connected, press  on the iTools menu bar. iTools will search the communications ports and TCPIP connections for recognisable instruments. Controllers connected with the configuration clip (CPI), will be found at address 255 regardless of the address configured in the controller.

When the instrument is detected a screen view similar to the one shown below will be displayed. The browser on the left shows the List Headers. To display parameters within a list double click the Header or select 'Parameter Explorer'. Click on a list header to display parameters associated with this list.

The instrument view may be turned on or off using the 'View' menu and selecting 'Panel Views'.

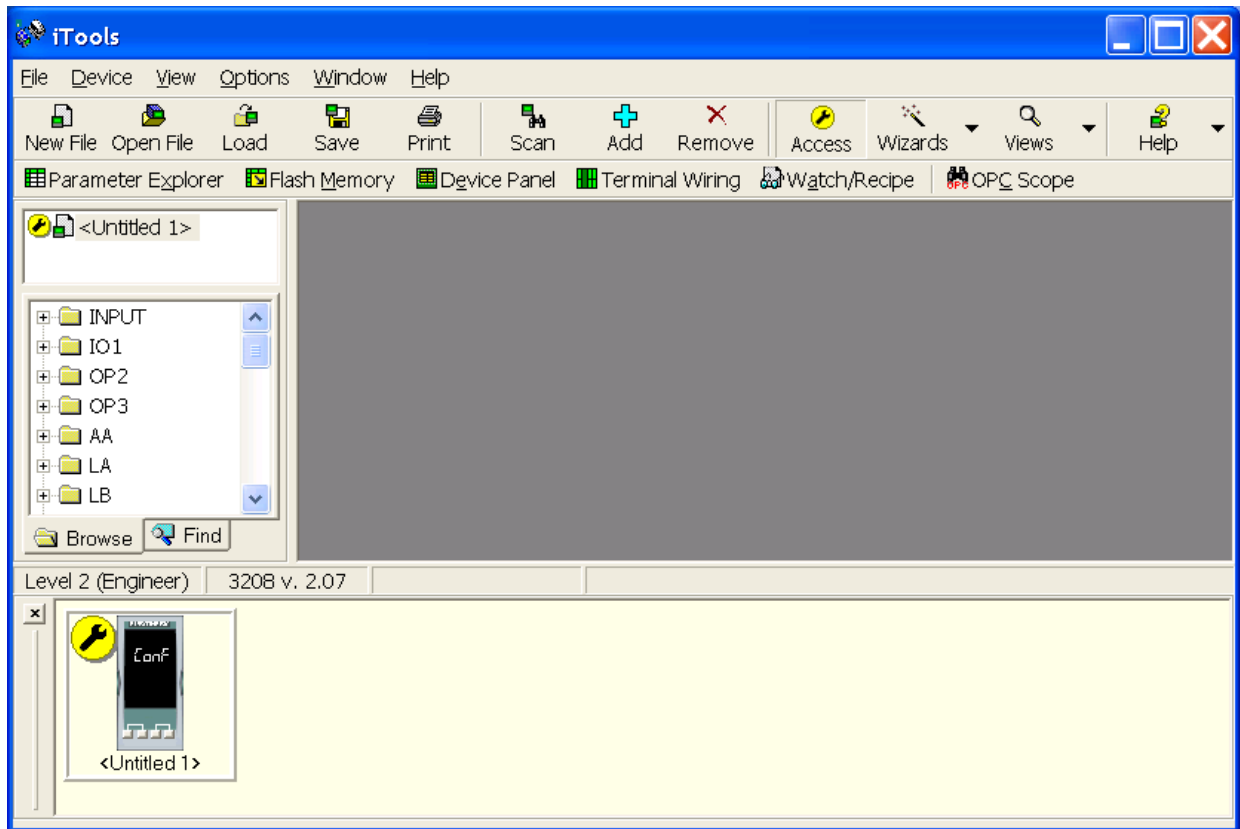

The instrument may be configured using a **Wizard** or from the **Browser** view above. The following pages show a number of examples of how to configure various functions using either of these features.

It is assumed that the user is generally familiar with iTools and has a general understanding of Windows.

17.4 Starting the Wizard

From the opening view shown in section 17.3, press



The controller will be set to configuration level. Since it will not operate the process in configuration level a warning message appears. When this is accepted the Wizard start up screen is shown:-

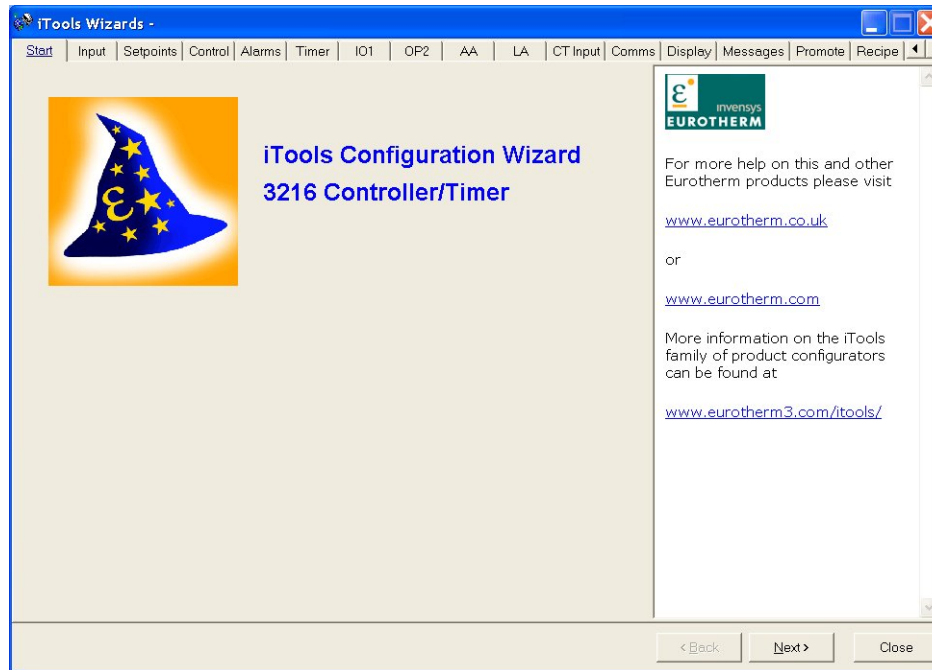

Select a tab to configure a function.

17.5 To configure the Input

17.5.1 Example 1 - Using the Wizard

Select the 'Input' tab

To configure the input type, open the drop down box and select the input to match the sensor in use on your process. When the drop down box is opened the parameter 'help' description is also displayed. This example configures the controller for a type J thermocouple

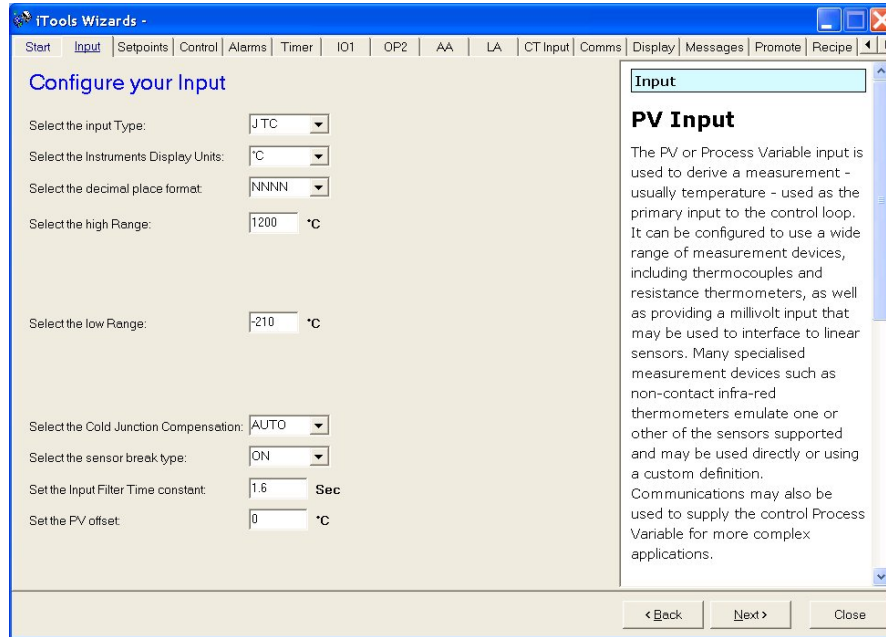

A 'help' text is shown to the right of the wizard. This describes the feature which is selected. A list of parameters which need to be configured follows this general description. Click on the parameter for a description of its function.

Other functions may be configured using the appropriate tab.

17.5.2 Example 2 – Using the Browser View

Press  (if necessary) to put the controller into configuration level.

Open the parameter list by double clicking INPUT in the browser or selecting 'Parameter Explorer'.

Select input type from the drop down. Other parameters can also be set using the drop downs or by setting the analogue values.

Parameters shown in blue, in the iTools view, are not alterable.

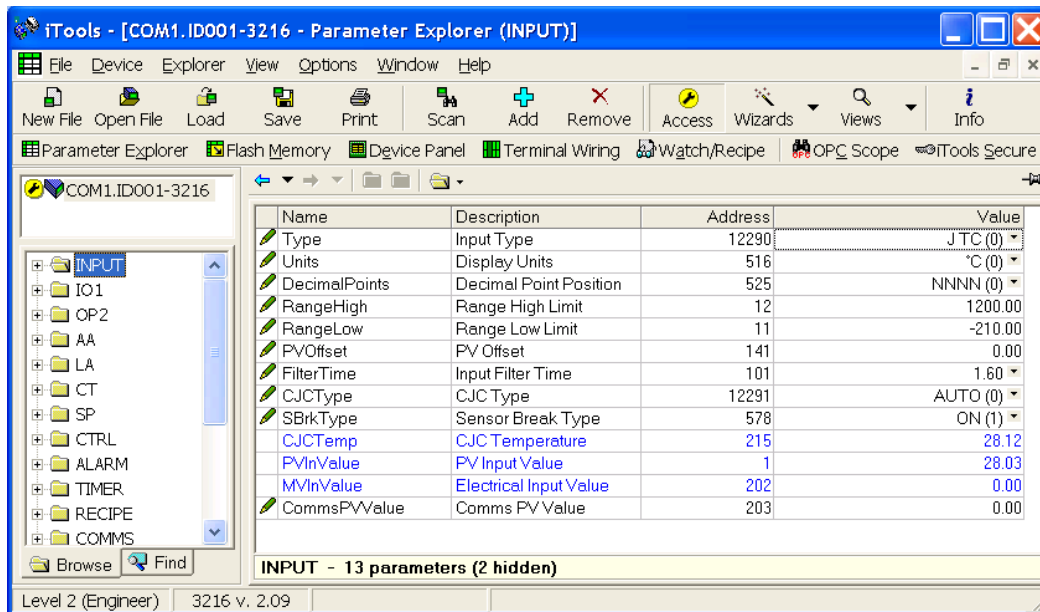

17.6 To Configure Alarms

17.6.1 Example 1: Using the Wizard

Up to four alarms are available in 3200 series controllers. Set the type of alarm, latching mode, blocking, threshold and hysteresis from drop down menus. Help text is shown together with a pictorial representation of the alarm operation.

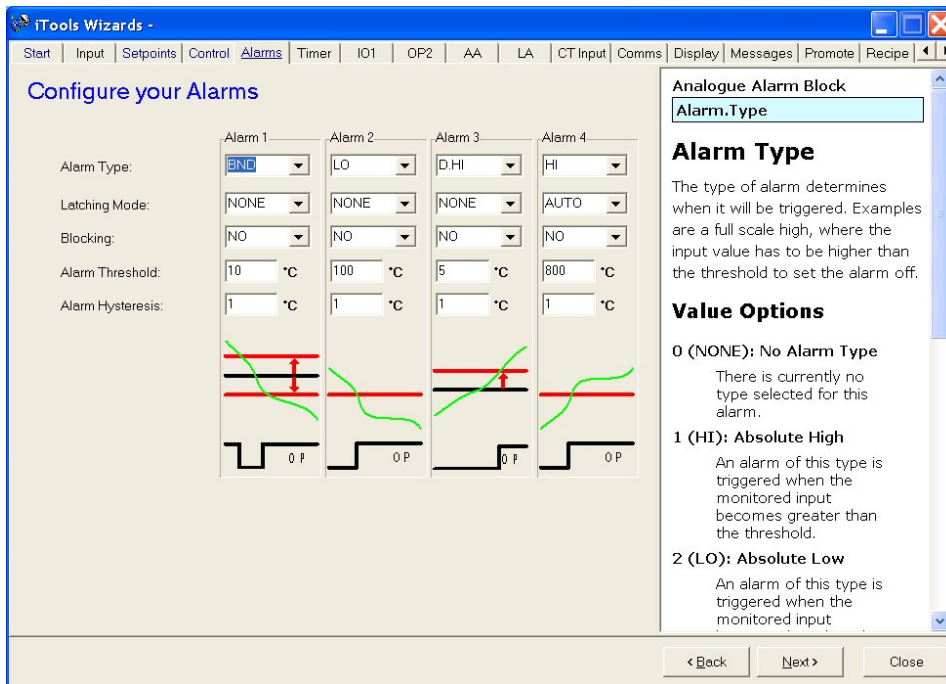

17.6.2 Example 2: Using the Browser View

1. Press  to put the controller into Configuration level
2. Select the list header from the browser – in this case 'ALARM' '1'

3. To configure 'Alarm Type' open the drop down under the 'Value' column

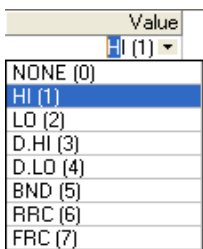

4. Select the alarm type – in this example HI. (1) is the enumeration of the parameter.

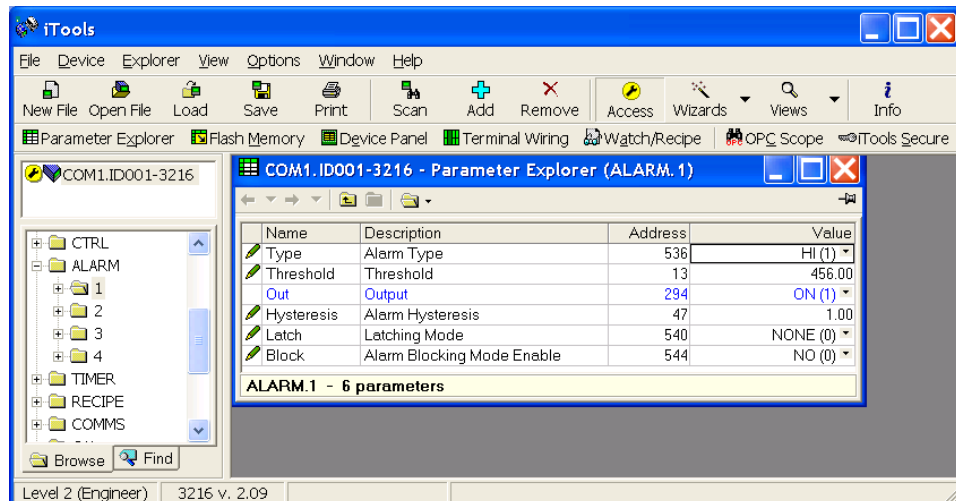

5. Select and set all other parameters using the same procedure

17.7 To Customise Messages

The message which scrolls across the controller display during normal operation may be customised.

17.7.1 Example 1: Using the Wizard

Select the 'Messages' tab.

Display the message 'OUT OF CONTROL' if both Alarm 1 and Alarm 2 are active.

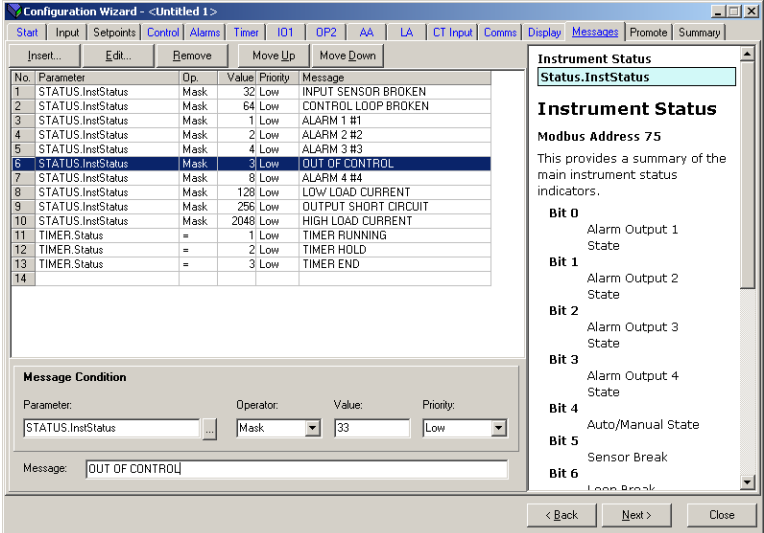
Operation	Action	Indication
Add a parameter	<p>Click where the parameter is required</p> <p>Select 'Insert'</p> <p>Choose the parameter from the pop up box eg 'STATUS InstStatus'</p> <p>The parameter may be edited, removed or its position changed by selecting the relevant tab</p>	
Set the Operator	<p>From the 'Operator:' drop down box select 'Mask' – see Note 1.</p> <p>Alternatively a message may be configured to appear if the enumeration of the parameter:-</p> <ul style="list-style-type: none"> = equals the 'Value' <> is greater or less than the 'Value' > is greater than the 'Value' < is less than the 'Value' 	
Set the value	<ol style="list-style-type: none"> Click in the 'Value' box and press enter 	<p>Instrument Status - Bitmap</p> <ul style="list-style-type: none"> B0 – Alarm 1 Status B1 – Alarm 2 Status B2 – Alarm 3 Status B3 – Alarm 4 Status B4 – Auto/Manual Status B5 – Sensor Break Status B6 – Loop Break Status B7 – CT Low load current alarm status B8 – CT High leakage current alarm status B9 – Program End B10 – PV Over-range (by > 5% of span) B11 – CT Overcurrent alarm status B12 – New Alarm Status B13 – Timer/Ramp Running B14 – Remote Fail, New Alarm B15 – Auto-tune Status <p>In each case, a setting of 1 signifies 'Active', 0 signifies 'Inactive'.</p>
The bitmap list is given here and in the Digital Comms chapter	<ol style="list-style-type: none"> From the pop up box either tick the bit field values or type in the decimal equivalent in 'New Value'. In this example 3 (alarm 1 + alarm 2). 	
Set the priority	<ol style="list-style-type: none"> From the drop down select Low Medium or High 	
Enter the message	<ol style="list-style-type: none"> In the message section enter OUT OF CONTROL 	
Download to the controller	<ol style="list-style-type: none"> Press <Back, Next> or Close to download the settings 	



Note 1:- Mask allows any combination of parameters in the above bitmap field to activate the custom message. The table below shows how this operates for the four alarm fields.

Value	Bitmap	Parameter (Alarm) active	Value	Bitmap	Parameter (Alarm) active
1	0001	Alarm 1	5	0101	Alarm 3 + Alarm 1
2	0010	Alarm 2	6	0110	Alarm 2 + Alarm 3
3	0011	Alarm 1 + Alarm 2	7	0111	Alarm 1 + Alarm 2 + Alarm 3
4	0100	Alarm 3	8	1000	Alarm 4

Other parameters can be added by extending this table.

17.7.2 Example 2: Using the Browser View

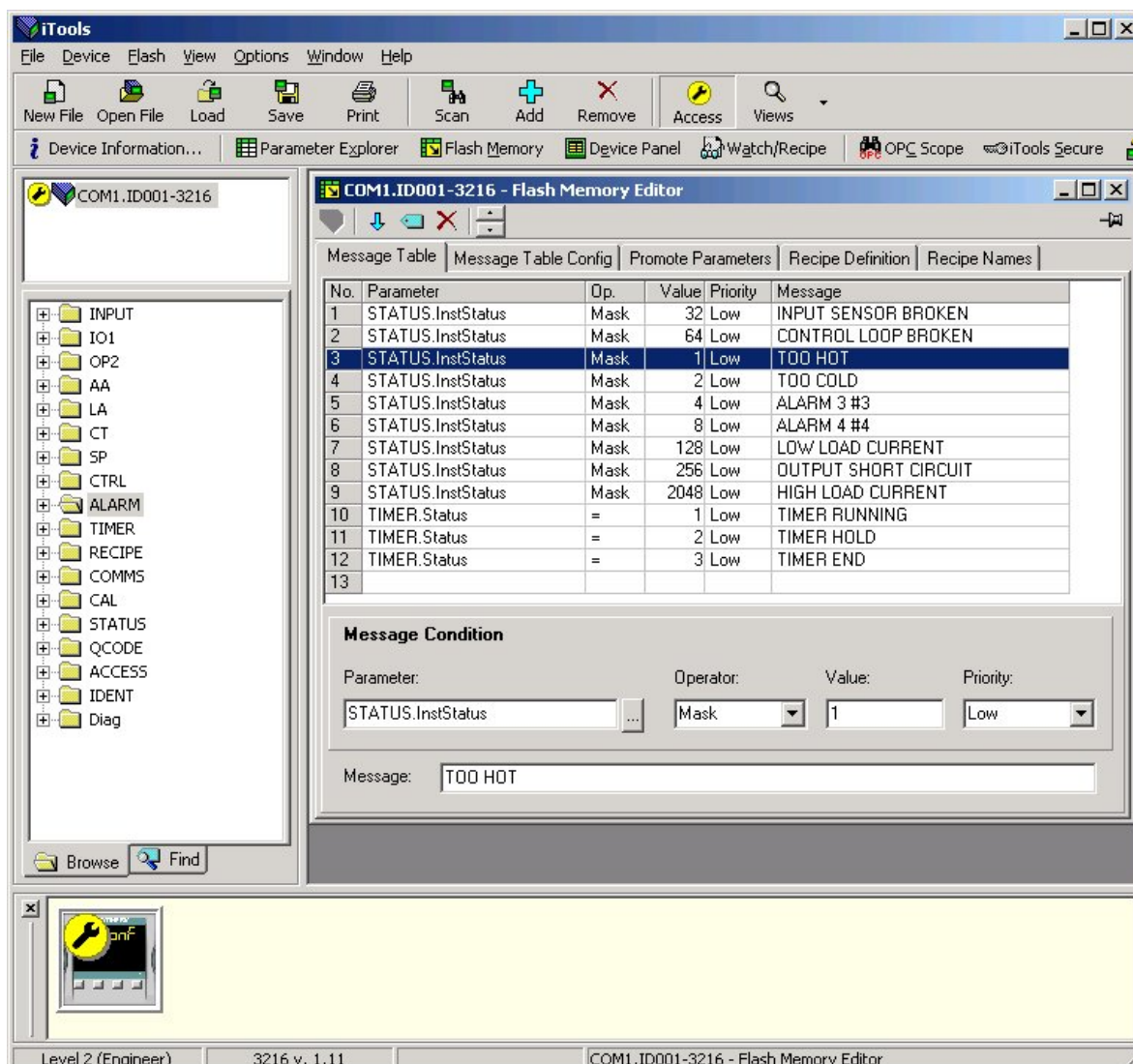

In this example the alarm 1 message will read 'TOO HOT'.

1. Press  and select the 'Message Table' tag.
2. Select Parameter 'ALARM1 #1'.
3. In the 'Message Condition' area change 'Message' to TOO HOT.
4. Press  'Update Device Flash Memory' button.



17.7.3 Example 3: Inverted Status Word

The Inverted Status Word is available in firmware versions 2.11+. It is used to generate a message when a bit in a status word is not true. For example, it may be applied to an alarm or event to indicate that the process is operating normally. The example below continues from the previous example and adds the message PROCESS OK on the controller when the Alarm 1 condition is not true.

1. Press  Flash Memory and select the 'Message Table' tag.
2. Add the 'InverseStatus' parameter as follows:-
 - a. Click where the parameter is required.
 - b. Select 'Insert' .
 - c. Select 'STATUSInverseStatus' from the pop up.

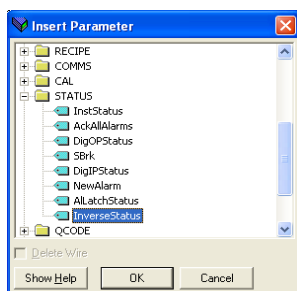

3. In the Operator box select 'Mask'.
4. In the Value box select 1 (Alarm 1 only).
5. In the message box enter 'PROCESS OK'.
6. Press  'Update Device Flash Memory' button.

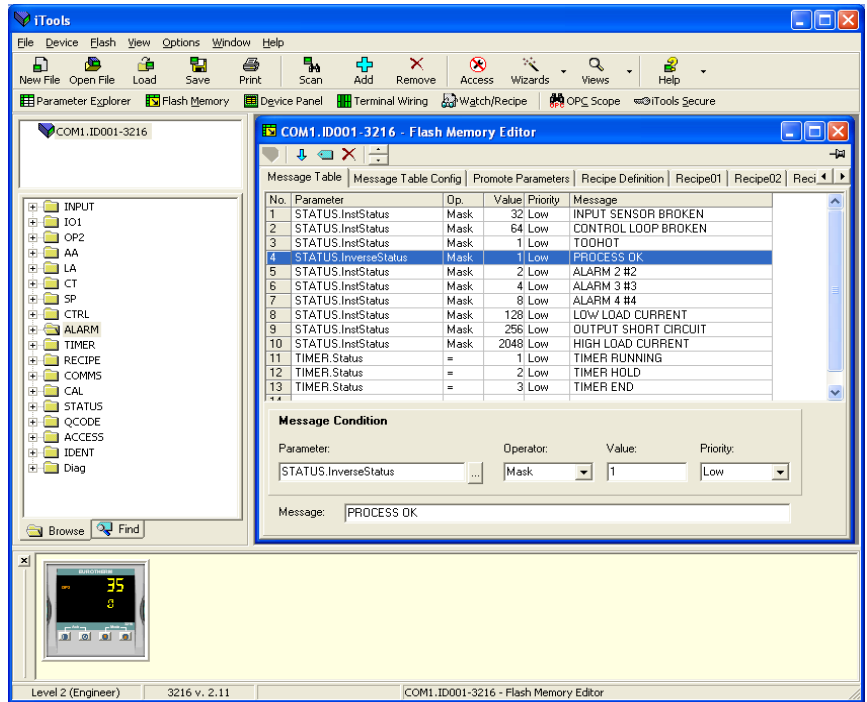

The controller will now indicate the scrolling message PROCESS OK when Alarm 1 is not true and TOO HOT when Alarm 1 is exceeded.

17.7.4 Example 4: Display the message ‘OUT OF CONTROL’ if both Alarm 1 and Alarm 2 are active.

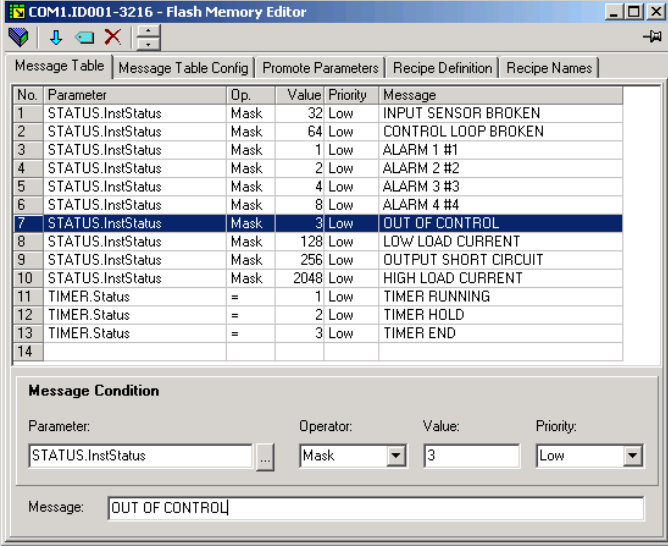
Operation	Action	Indication
Add a parameter	<ol style="list-style-type: none"> Right click where the parameter is required Select ‘Insert Item’ Choose the parameter from the pop up box eg ‘STATUS InstStatus’ 	 <p>The screenshot shows a software window titled 'COM1.ID001-3216 - Flash Memory Editor'. It contains a 'Message Table' with columns: No., Parameter, Op., Value, Priority, and Message. Row 7 is highlighted, showing 'STATUS.InstStatus', 'Mask', '3', 'Low', and 'OUT OF CONTROL'. Below the table is a 'Message Condition' section with fields for Parameter (STATUS.InstStatus), Operator (Mask), Value (3), and Priority (Low). The Message field contains 'OUT OF CONTROL'.</p>
Set the Operator	<ol style="list-style-type: none"> From the Operator drop down box select ‘Mask’ <p>See also note 1 below Alternatively a message may be configured to appear if the enumeration of the parameter:- = equals the ‘Value’ != is not equal to the ‘Value’ > is greater than the ‘Value’ < is less than the ‘Value’</p>	
Set the value	<ol style="list-style-type: none"> Click in the ‘Value’ box and press enter From the pop up box either tick the bit field values or type in the decimal equivalent in ‘New Value’. In this example 3. 	<p>Instrument Status - Bitmap</p> <ul style="list-style-type: none"> B0 – Alarm 1 Status B1 – Alarm 2 Status B2 – Alarm 3 Status B3 – Alarm 4 Status B4 – Auto/Manual Status B5 – Sensor Break Status B6 – Loop Break Status B7 – CT Low load current alarm status B8 – CT High leakage current alarm status B9 – Program End B10 – PV Over-range (by > 5% of span) B11 – CT Overcurrent alarm status B12 – New Alarm Status B13 – Timer/Ramp Running B14 – Remote Fail, New Alarm B15 – Auto-tune Status <p>In each case, a setting of 1 signifies ‘Active’, 0 signifies ‘Inactive’.</p>
The bitmap list is given here and in the Digital Comms chapter		
Set the priority	<ol style="list-style-type: none"> From the drop down select Low Medium or High 	
Enter the message	<ol style="list-style-type: none"> In the message section enter OUT OF CONTROL 	
Download to the controller	<ol style="list-style-type: none"> Press <Back, Next> or Close to download the settings 	

Note 1: Mask allows any combination of parameters in the above bitmap field to activate the custom message. The table below shows how this operates for the four alarm fields.

Value	Bitmap	Parameter (Alarm) active
1	0001	Alarm 1
2	0010	Alarm 2
3	0011	Alarm 1 + Alarm 2
4	0100	Alarm 3
5	0101	Alarm 3 + Alarm 1
6	0110	Alarm 2 + Alarm 3
7	0111	Alarm 1 + Alarm 2 + Alarm 3
8	1000	Alarm 4

Other parameters can be added by extending this table.

17.8 To Promote Parameters

The list of parameters which are available in operator levels 1 or 2 can be changed using the 'Promote' wizard. Access can be set to Read Only or Read/Write.

17.8.1 Example 1: Using the Wizard

Select 'Promote' tab

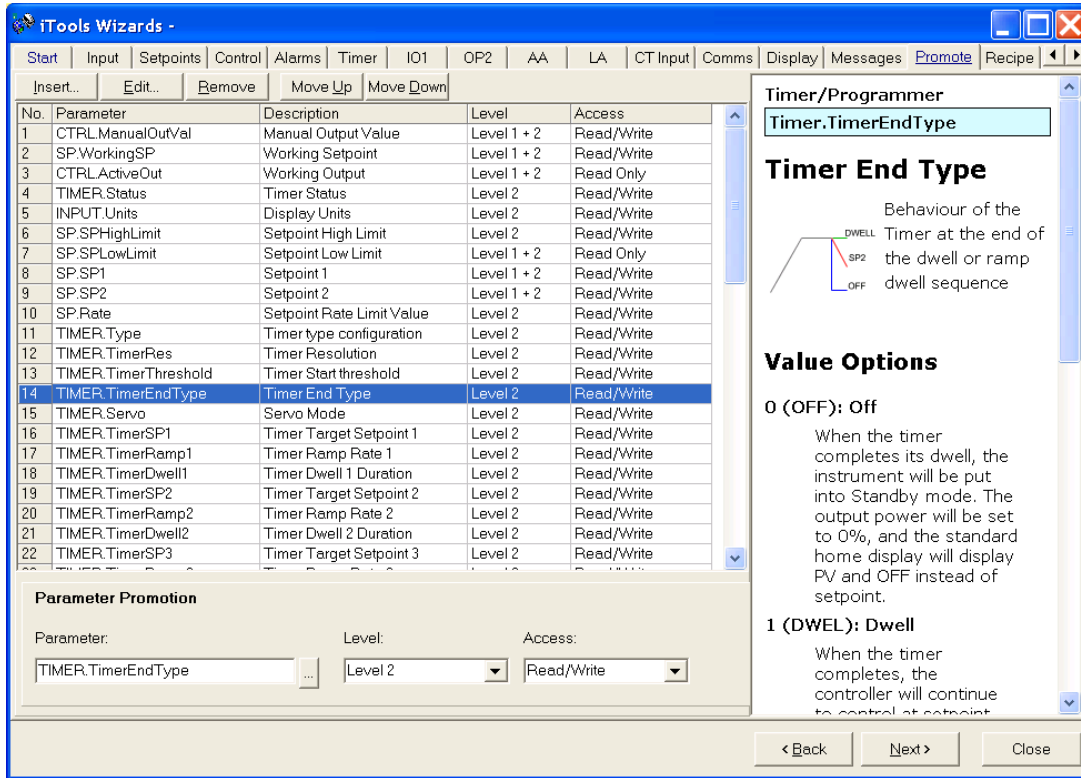

Parameters can be Inserted, Edited, Removed or Moved up or down the list.

When inserting or editing a pop up box appears as shown.



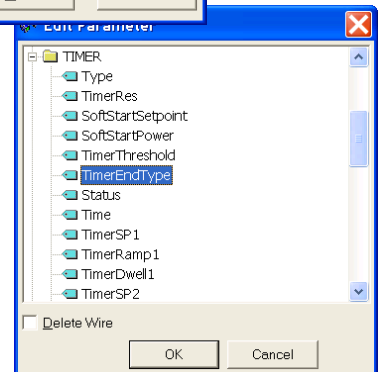

Highlight a parameter and in the **Parameter Promotion** section, select the level of access you wish to be available to the available to the operator and whether it should be Read/Write or Read only.

The list of parameters which are available in operator levels 1 or 2 can be changed using iTools.



17.8.2 Example 2: Using the Browser view

In this example the parameter 'OP2.Sense' is added to the to the Level 2 list.

1. Press  Flash Memory and select the Memory Table tab
2. Select the 'Promote Parameters' tab
3. Highlight the position where you want the new parameter to be placed
4. Press  button and from the pop up window select the required parameter.
Alternatively use the  button.
5. In the Level box select Level 2 (or Level 1 + 2 if it is required to display this parameter in Level 1 as well)
6. In the Access box select 'Read Only' or 'Read/Write' as required
7. Press  to remove a selected parameter
8. Press  'Update Device Flash Memory' button

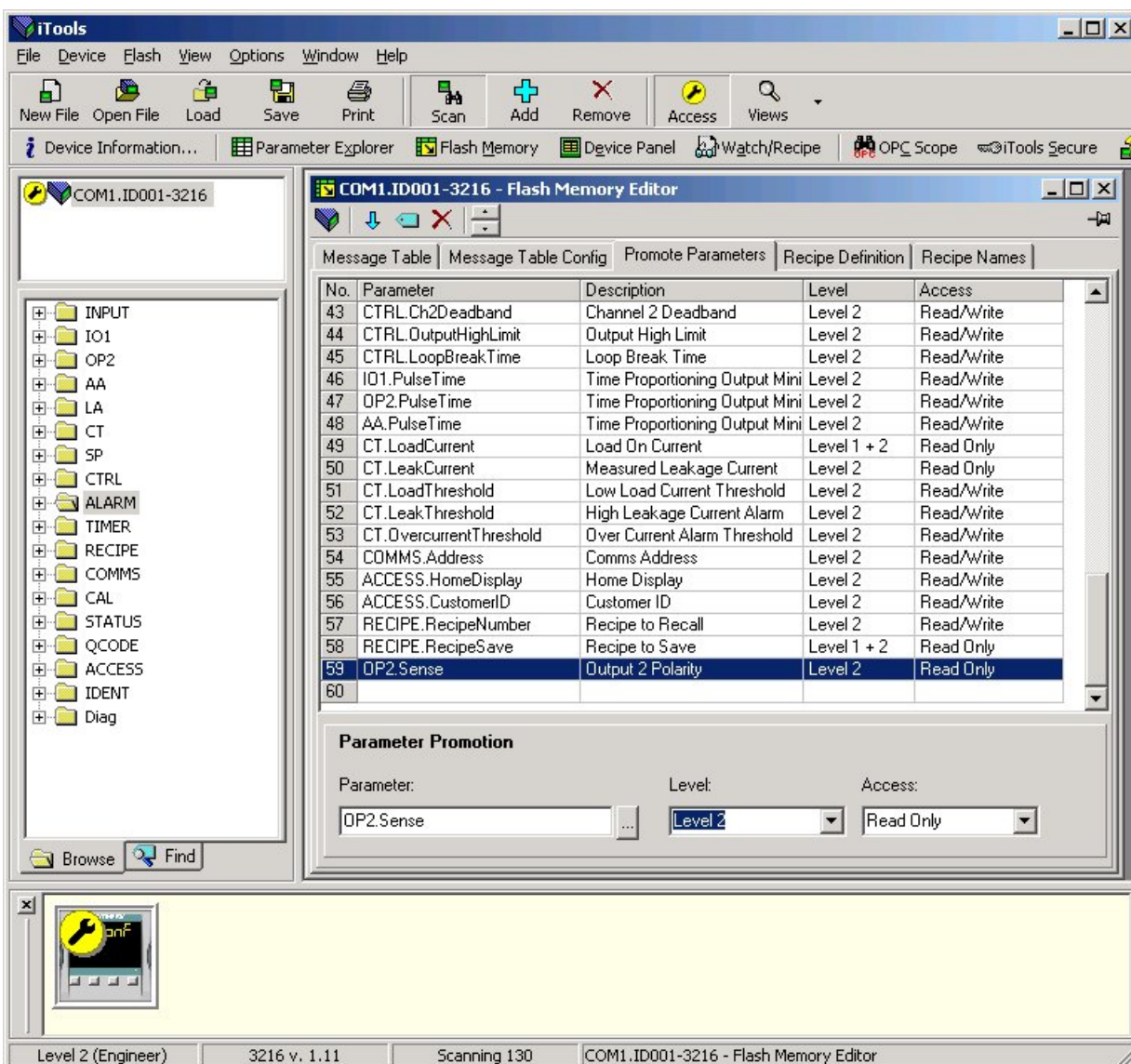
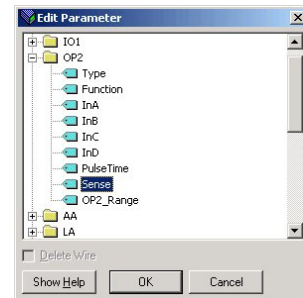

17.9 To Load A Special Linearisation Table

In addition to the built in standard linearisation tables, custom tables can be downloaded from files.

17.9.1 Example: Using the Browser view

1. Press  Load
2. Select the linearisation table to be loaded from files with the extension .mtb. Linearisation files for different sensor types are supplied with iTools and may be found in Program Files → Eurotherm → iTools → Linearisations → Thermocouple etc.

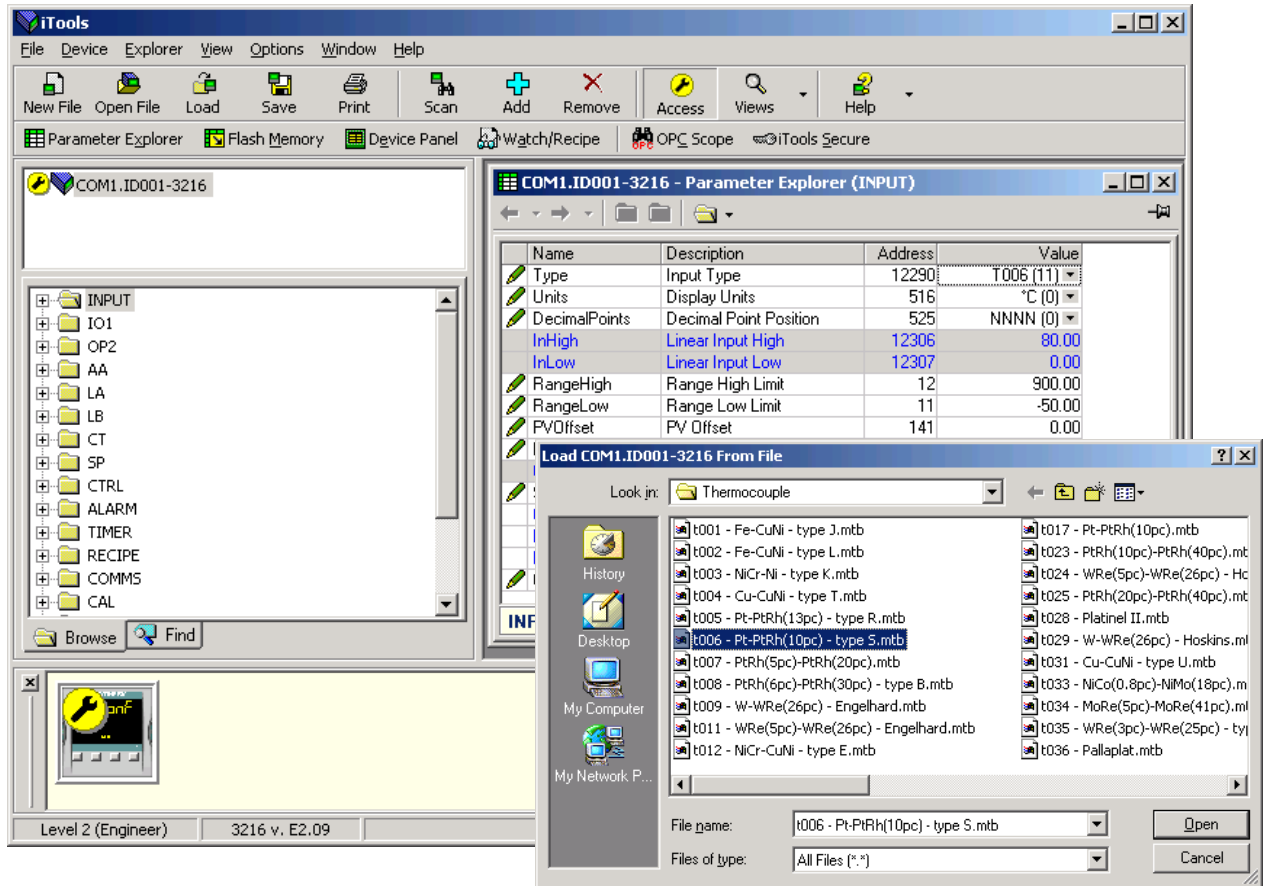

3. In this example a Pt-PtRh(10%) thermocouple has been loaded into the controller. The controller will display the



linearisation table downloaded:-

17.10 To Set up Recipes

A recipe can store up to 38 parameters, as listed in section 14.3.1. Up to five recipes are available in 3200 series controllers, as described in section 14.

17.10.1 Example 1: Using the Browser view

Set Two Different Alarm Thresholds and Store in Recipes 1 and 2

1. Set an alarm threshold - see example 17.6.2.
2. Select 'RECIPE' in the browser
3. In RecipeSave, select the recipe number e.g. 1
4. Set the alarm threshold to another value and save in Recipe 2
5. In RecipeNumber choose the recipe to run. This can also be done through the controller user interface

The screenshot shows the iTools software interface. The main window displays two stacked windows for parameter exploration. The top window is titled "COM1.ID001-3216 - Parameter Explorer (RECIPE)" and shows a table with two parameters:

Name	Description	Address	Value
RecipeNum	Recipe to Recall	313	1 (1)
RecipeSave	Recipe to Save	314	DONE (6)

Below the table, it indicates "RECIPE - 2 parameters".

The bottom window is titled "COM1.ID001-3216 - Parameter Explorer (ALARM. 1)" and shows a table with six parameters:

Name	Description	Address	Value
Type	Alarm Type	536	HI (1)
Threshold	Threshold	13	456.00
Out	Output	294	ON (1)
Hysteresis	Alarm Hysteresis	47	1.00
Latch	Latching Mode	540	NONE (0)
Block	Alarm Blocking Mode Enable	544	NO (0)

Below the table, it indicates "ALARM.1 - 6 parameters".

The left-hand side of the interface shows a tree view of the device's parameter structure, including folders like INPUT, IO1, OP2, AA, LA, CT, SP, CTRL, ALARM, TIMER, RECIPE, and COMMS. The "RECIPE" folder is expanded, showing sub-folders like RecipeNumbe and RecipeSave.

Any of the 38 parameters can be set up in any of the five recipes using the above procedure.

It may be more convenient to open more than one parameter list as shown in the above view. To do this, double click on each list header in turn. The lists can be arranged using Window in the main menu and choose Tile Vertically, Tile Horizontally or Cascade.

17.10.2 Example 2: Using the Wizard

Select the 'Recipe' tab

17.10.2.1 Recipe Definition

Select 'Recipe Definition' tab to display the default parameters available to be stored in recipe. Double click on the parameter in the 'Wired From' column, a pop up allows you to delete or change to a different parameter.

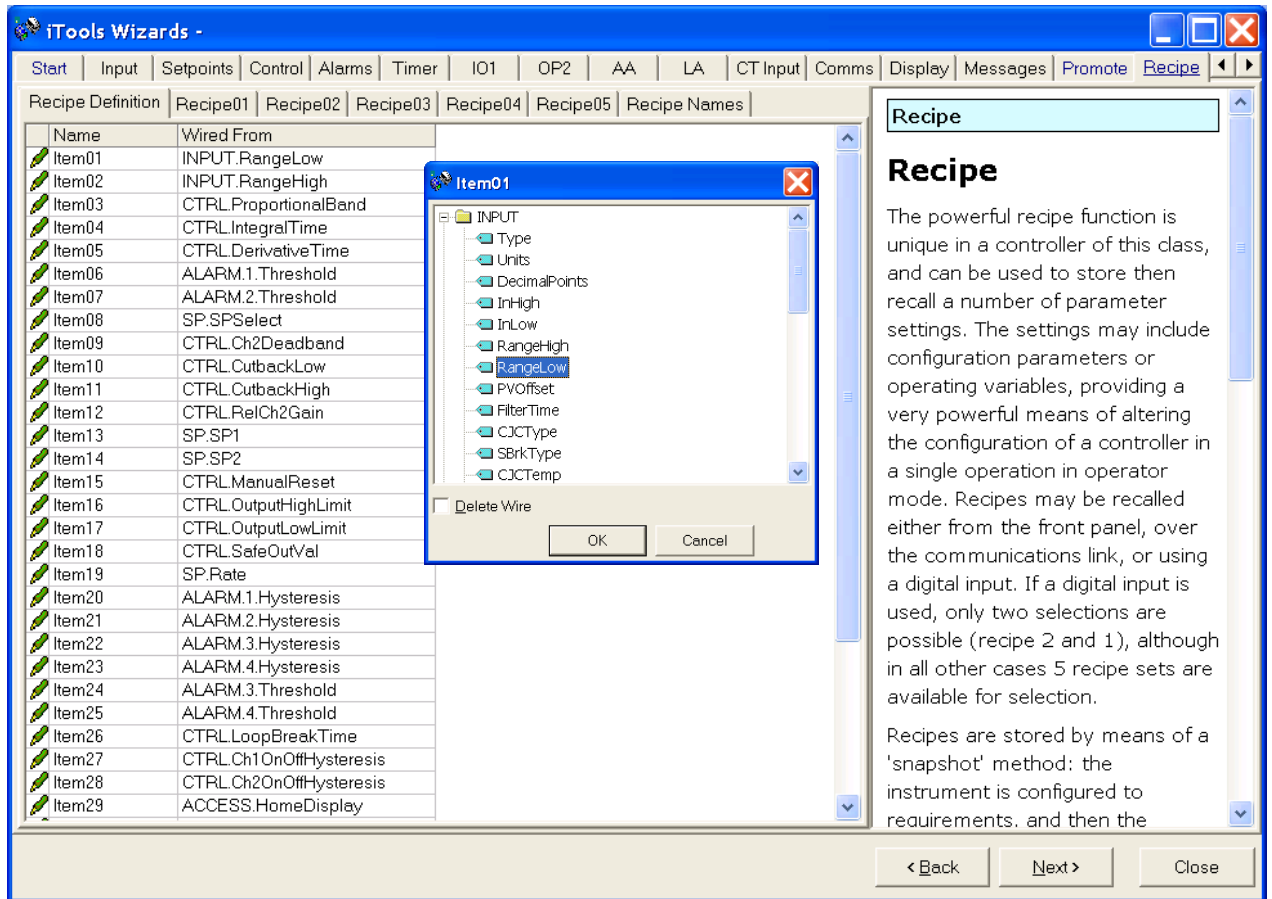

17.10.2.2 Editing Recipe Values

Select any one of the Recipe01 to 05 tabs. It is necessary to set the values of all parameters. Start with the first followed by all other parameters.

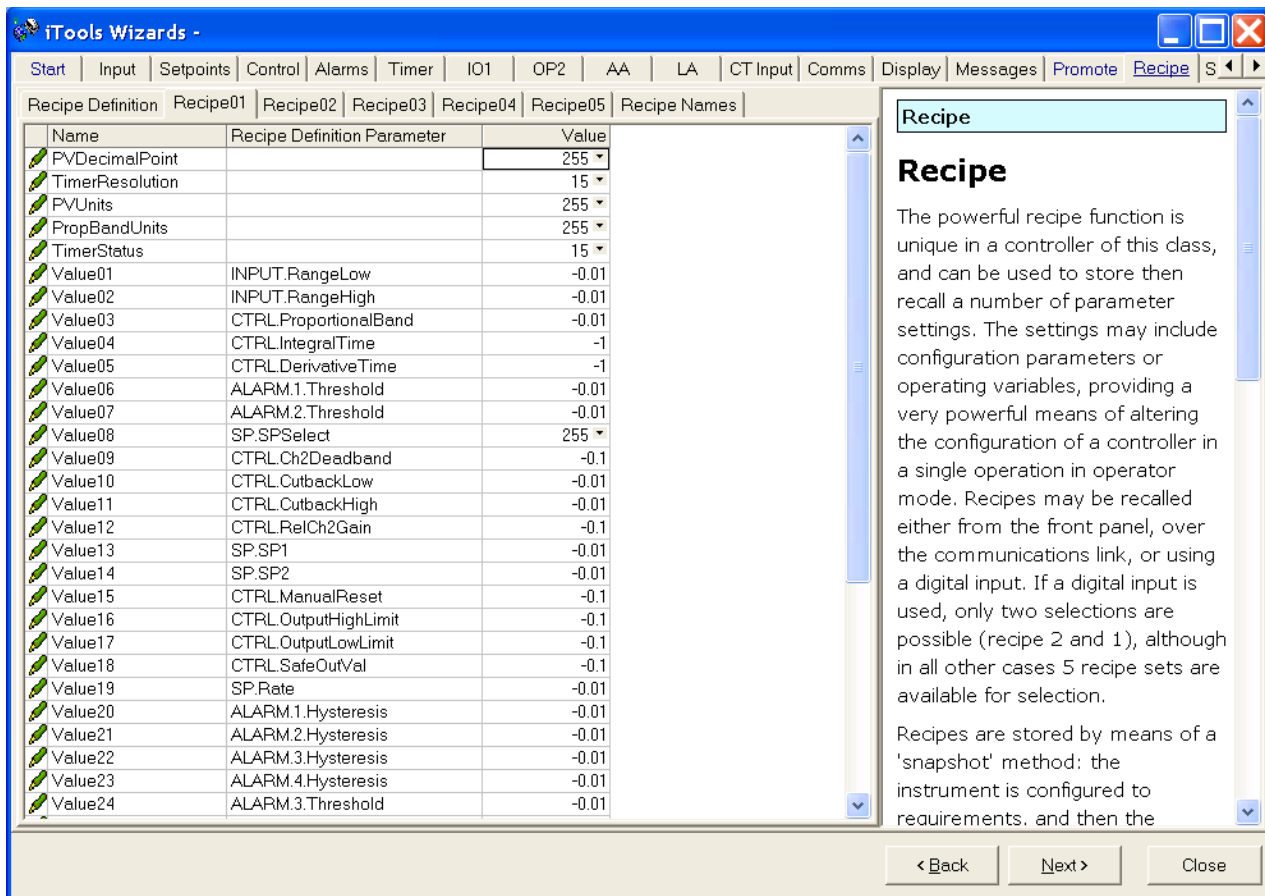

To download the new values, press Next> or select any other tab. There is a delay whilst the recipe updates. To ensure the controller accepts the new recipe values, select another recipe in the controller itself, then go back to the recipe in which the changes were made.

17.10.2.3 Recipe Names

Names can be given to each of the five recipes. Each name is limited to a maximum of four characters – this being the limit of the characters which can be displayed on the front panel of the controller. A character shown as '?' signifies that it cannot be displayed on the controller due to font limitations. To download a new recipe name press Next (or Back or select any other tab).

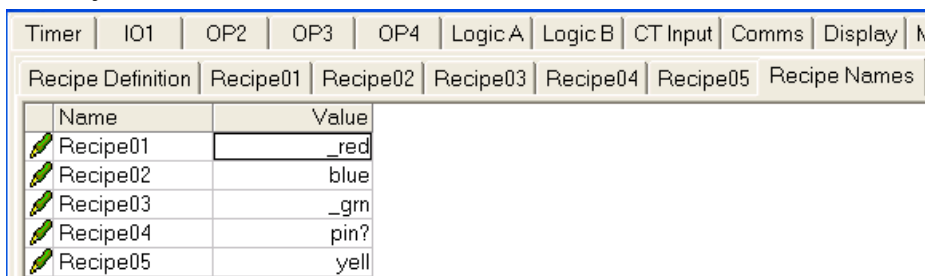

17.11 Summary

The terminal connections for the functions which have been configured together with a description of each function.

17.11.1 Example 1: Using the Wizard

Press 'Summary' tab.

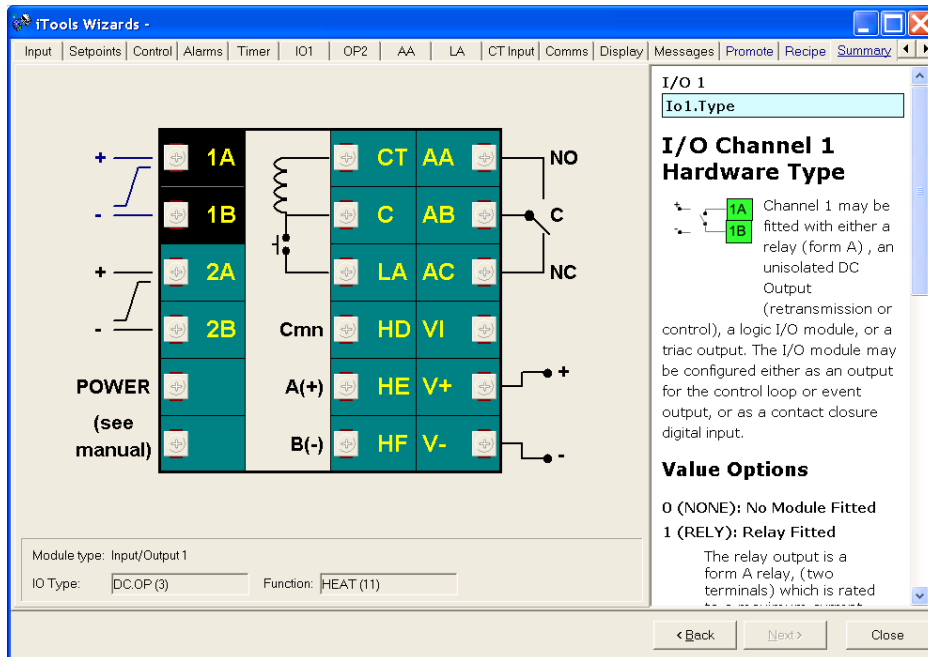

17.11.2 Example 2: Using the browser view.

Press Terminal Wiring

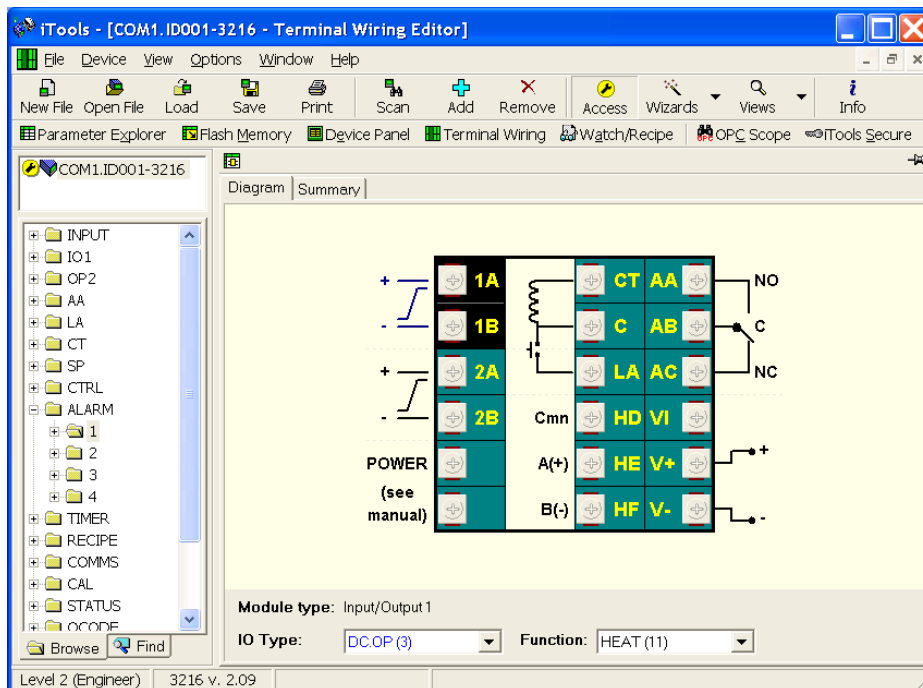

A summary of the features configured may be selected using the 'Summary' tab.

	Function
DC.OP (3)	[IO1.Function] - HEAT (11)
DC.OP (3)	[OP2.Function] - COOL (12)
CT Input	[CT.Type] - CT.IN (1)
Logic Input A	[LA.Type] - LIP (1) [LA.InputFunction] - SBY (49)
Digital Comms	[COMMS.Id] - R485 (1)
Output AA	[AA.Type] - RELY (1) [AA.Function] - D.OUT (1)
Sensor Input	[INPUT.Type] - CMS (10)

17.12 Cloning

The cloning feature allows the configuration and parameter settings of one instrument to be copied into another. Alternatively a configuration may be saved to file and this used to download to connected instruments. The feature allows new instruments to be rapidly set up using a known reference source or standard instrument. Every parameter and parameter value is downloaded to the new instrument which means that if the new instrument is used as a replacement it will contain exactly the same information as the original. Cloning is generally only possible if the following applies:

- The target instrument has the same hardware configuration as the source instrument
- The target instrument firmware (i.e. Software built into the instrument) is the same as or a later version than that of the source instrument. The instrument firmware version is displayed on the instrument when power is applied.
- Generally, cloning will copy all operational, engineering and configuration parameters that are writable. **The communications address is not copied.**

Every effort has been made to ensure that the information contained within the clone files is a replica of that configured in the instrument. It is the users responsibility to ensure that the information cloned from one instrument to another is correct for the process to be controlled, and that all parameters are correctly replicated into the target instrument.

Below is a brief description of how to use this feature. Further details are available in the iTools Handbook.

17.12.1 Save to File

The configuration of the controller made in the previous sections may be saved as a clone file. This file can then be used to download the configuration to further instruments.

From the File menu use 'Save to File' or use the 'Save' button on the Toolbar.

17.12.2 To Clone a New Controller

Connect the new controller to iTools and Scan to find this instrument as described at the beginning of this chapter.

From the File menu select 'Load Values From File' or select 'Load' from the toolbar. Choose the required file and follow the instruction. The new instrument will be configured to this file.

18. Appendix A TECHNICAL SPECIFICATION

General

Temperature limits	Operation: 0 to 55°C (32 to 131°F), Storage: -10 to 70°C (14 to 158°F)			
Humidity limits	Operation: RH: 5 to 90% non-condensing Storage: RH: 5 to 90% non-condensing			
Panel sealing	IP65			
Shock	BS EN61010			
Vibration	2g peak, 10 to 150Hz			
Altitude	<2000 metres			
Atmospheres	Not suitable for use above 2000m or in explosive or corrosive atmospheres.			
Electromagnetic compatibility (EMC)	EN61326-1 Suitable for domestic, commercial and light industrial as well as heavy industrial environments. (Class B emissions, Industrial Environment immunity). Low supply voltage versions are suitable for industrial environments only.			
Installation category II	The rated impulse voltage for equipment on nominal 230V supply is 2500V			
Pollution degree 2	Normally only non conductive pollution occurs. Occasionally, however, a temporary conductivity caused by condensation shall be expected.			

Physical

	3216	3208	3204	32h8
Panel mounting	1/16 DIN	1/8 DIN	1/4 DIN	1/8 DIN
Weight grams	250	350	420	350

Operator interface

Type	LCD TN with backlight			
Main PV display	4 digits green			
Lower display	3216	3208	3204	
	5 character starburst green			
	32h8 9 character starburst green			
Status beacon	Units, outputs, alarms, active setpoint			

Power requirements

3216	Line Supply 100 to 230Vac +/-15% 48 - 62Hz
	Low Voltage Supply 24Vac/dc 24Vac -15%, +10%. 48 - 62Hz 24Vdc -15%, +20% 6W
3208, 3204, 32h8	Line Supply 100 to 230Vac, +/-15% 48 - 62Hz, max 8W
	Low Voltage Supply 24Vac/dc 24Vac, -15%, +10% 24Vdc, -15%, +20%, $\pm 5\%$ ripple voltage, max 8W

Approvals

	CE, cUL listed (file ES7766), Gost, Suitable for use in Nadcap and AMS2750D applications under Systems Accuracy Test calibration conditions
EN14597TR	Automatic electronic control Type 1A mandatory automatic reset A with full disconnection, number of automatic cycles for each automatic action is 250000. Approval number TR1229.

Transmitter PSU

Isolation	264Vac double insulated
Output Voltage	24Vdc, >28mA, <33mA

Communications: serial communications option

Protocol	Modbus RTU slave Modbus RTU Master broadcast (1 parameter)
Isolation	264Vac double insulated
Transmission standard	EIA232 or EIA485 2-wire 3216 only EIA485 4-wire optional

Process Variable Input

Calibration accuracy	<+0.25% of reading ± 1 LSD ⁽¹⁾
Sample rate	4Hz (250mS)
Isolation	264Vac double insulated from the PSU and communications
Resolution (μ V)	< 0.5 μ V when using a 1.6 second filter
Resolution (effective bits)	>17 bits
Linearisation accuracy	<0.1% of reading
Drift with temperature	<50ppm (typical) <100ppm (worst case)
Common mode rejection	48 - 62 Hz, >-120db
Series mode rejection	48 - 62 Hz, >-93db
Input impedance	100M Ω
Cold junction compensation	>30 to 1 rejection of ambient temperature
External cold junction	Reference of 0°C
Cold junction accuracy	< ± 1 °C at 25°C ambient
Process Linear	-10 to 80mV, 0 to 10V with external potential divider module 100K Ω /806 Ω
Thermocouple Types	K, J, N, R, S, B, L, T, C, custom download ⁽²⁾
RTD/PT100 Type	3-wire, Pt100 DIN43760
Bulb current	0.2mA
Lead compensation	No error for 22 ohms in all 3 leads
Input filter	Off to 59.9 seconds
Zero offset	User adjustable over the full display range
User calibration	2-point gain & offset

Notes

- (1) Calibration accuracy quoted over full ambient operating range and for all input linearisation types.
- (2) Contact Eurotherm for details of availability of custom downloads for alternative sensors.

AA relay

Type	Form C changeover
Rating	Min: 12V, 100mA dc Max: 2A, 264Vac resistive
Functions	Control, alarms or events

Current Transformer Input

Input current	0 to 50mA rms 48/62Hz, 10Ω burden resistor fitted inside the module
Calibration accuracy	<1% of reading (typical) <4% of reading (worst case)
Isolation	By using external CT
Input impedance	<20Ω
Scale	10, 25, 50 or 100Amps
Functions	Partial load failure, SSR fault

Digital input (DigIn A/B, B not in 3216)

Contact closure	Contact open >600Ω Contact closed <300Ω
Input current	<13mA
Isolation	None from PV or system 264Vac double insulated from PSU and communications
Functions	Include alarm acknowledge, SP2 select, manual keylock, timer functions, standby select, RSP select

Logic I/O module Output

Rating	On/High 12Vdc at <44mA Off/Low <300mV at 100μA
Isolation	None from PV or system 264Vac double insulated from PSU and communications
Functions	Control, alarms or events

Logic I/O module Digital input

Contact closure	Contact open >500Ω Contact closed <150Ω
Isolation	None from PV or system 264Vac double insulated from PSU and communications
Functions	Include alarm acknowledge, SP2 select, manual keylock, timer functions, standby select, RSP select

Relay output channels

Type	Form A (normally open)
Rating	Min: 12V, 100mA dc Max: 2A, 264Vac resistive
Functions	Control, alarms or events

Triac output

Rating	0.75A rms 30 to 264V rms (resistive load)
Isolation	264Vac double insulated
Functions	Control, alarms or events

Analogue output ⁽³⁾ OP1, OP2 and OP3 (OP3 not available in 3216)

Rating	0-20mA into <500Ω
Accuracy	± (<1% of reading + <100μA) [<50μA for OP3]
Resolution	13.5 bits [13.6 bits for OP3]
Isolation	264Vac double insulated from PSU and communications. Module code C and OP3 provides full 264V double insulated
Functions	Control, retransmission
Note (3)	Voltage output can be achieved by external adaptor

Remote SP input

Calibration Accuracy	<± 0.25% of reading ± 1LSD
Sample Rate	4Hz (250mS)
Isolation	264Vac double insulated from instrument
Resolution	<0.5mV for 0-10V input, or <2μA for 4-20mA
Resolution (effective bits)	>14 bits
Drift with temperature	<50ppm typical, <150ppm worst case
Common mode rejection	48 - 62 Hz, >-120db
Series mode rejection	48 - 62 Hz, >-90db
Input Impedance	>222Kohm (Volts) 2.49R (Current)
Normal input range	0 – 10V and 4 – 20mA
Max input range	-1V to 11V and 3.36mA to 20.96mA

Software features**Control**

Number of loops	1
Loop update	250mS
Control types	PID, ON/OFF, VP
Cooling types	Linear, fan, oil, water
Modes	Auto, manual, standby, forced manual
Overshoot inhibition	High, low

Alarms

Number	4
Type	Absolute high and low, deviation high, low or band, rate of change
Latching	Auto or manual latching, non-latching, event only
Output assignment	Up to four conditions can be assigned to one output

Setpoint programmer

Program function	1 program x 8 segments with one event output (by using recipes five SP programs can be stored)
Start mode	Servo from PV or SP
Power fail recovery	Continue at SP or ramp back from PV
Guaranteed soak	Inhibits dwell timing until PV within limits

Timer

Modes	Dwell when SP reached, delayed control action, soft start limits power below PV threshold
-------	---

Current monitor

Alarm types	Partial load failure, over current, SSR short circuit, SSR open circuit
Indication type	Numerical or ammeter

Custom messages

Number	15 scrolling text messages
No. of characters	127 characters per message max
Languages	English, German, French, Spanish, Italian
Selection	Active on any parameter status using conditional command

Recipes

Number	5 with 38 parameters
Selection	Key press, via communications or dig. IO

19. Parameter Index

This is a list of parameters used in 3200 series controllers in alphabetical order together with the section in which they are to be found.

Mnemonic	Parameter Description	Location
1.ID	I/O 1 TYPE	IO1 List Section 9.1
1.D.IN	DIGITAL INPUT FUNCTION	IO1 List Section 9.1
1.FUNC	I/O 1 FUNCTION	IO1 List Section 9.1
1.PLS	OUTPUT 1 MINIMUM PULSE TIME	IO1 List Section 9.1
1.RNG	DC OUTPUT RANGE	IO1 List Section 9.1.1
1.SENS	I/O 1 SENSE	IO1 List Section 9.1
1.SRC.A	I/O 1 SOURCE A	IO1 List Section 9.1
1.SRC.B	I/O 1 SOURCE B	IO1 List Section 9.1
1.SRC.C	I/O 1 SOURCE C	IO1 List Section 9.1
1.SRC.D	I/O 1 SOURCE D	IO1 List Section 9.1
2.FUNC	FUNCTION	OP2 List Section 9.1.7
2.ID	OUTPUT 2 TYPE	OP2 List Section 9.1.7
2.PLS	OUTPUT MINIMUM PULSE TIME	OP2 List Section 9.1.7
2.RNG	DC OUTPUT RANGE	OP2 List Section 9.1.7
2.SENS	SENSE	OP2 List Section 9.1.7
2.SRC.A	I/O 2 SOURCE A	OP2 List Section 9.1.7
2.SRC.B	I/O 2 SOURCE B	OP2 List Section 9.1.7
2.SRC.C	I/O 2 SOURCE C	OP2 List Section 9.1.7
2.SRC.D	I/O 2 SOURCE D	OP2 List Section 9.1.7
3.FUNC	FUNCTION	OP3 List Section 9.1.8
3.ID	OUTPUT 3 TYPE	OP3 List Section 9.1.8
3.PLS	OUTPUT MINIMUM PULSE TIME	OP3 List Section 9.1.8
3.RNG	DC OUTPUT RANGE	OP3 List Section 9.1.8
3.SENS	SENSE	OP3 List Section 9.1.8
3.SRC.A	I/O 3 SOURCE A	OP3 List Section 9.1.8
3.SRC.B	I/O 3 SOURCE B	OP3 List Section 9.1.8
3.SRC.C	I/O 3 SOURCE C	OP3 List Section 9.1.8
3.SRC.D	I/O 3 SOURCE D	OP3 List Section 9.1.8
4.FUNC	FUNCTION	AA Relay List (OP4) Section 9.1.9
4.PLS	OUTPUT MINIMUM PULSE TIME	AA Relay List (OP4) Section 9.1.9
4.SENS	SENSE	AA Relay List (OP4) Section 9.1.9
4.SRC.A	I/O 4 SOURCE A	AA Relay List (OP4) Section 9.1.9
4.SRC.B	I/O 4 SOURCE B	AA Relay List (OP4) Section 9.1.9
4.SRC.C	I/O 4 SOURCE C	AA Relay List (OP4) Section 9.1.9
4.SRC.D	I/O 4 SOURCE D	AA Relay List (OP4) Section 9.1.9
4.TYPE	OUTPUT 4 TYPE	AA Relay List (OP4) Section 9.1.9
A1.---	ALARM 1 SETPOINT	Alarm Parameters Section 12.3

Mnemonic	Parameter Description	Location
A1.BLK	ALARM 1 BLOCKING	Alarm Parameters Section 12.3
A1.HYS	ALARM 1 HYSTERESIS	Alarm Parameters Section 12.3
A1.LAT	ALARM 1 LATCHING TYPE	Alarm Parameters Section 12.3
A1.STS	ALARM 1 OUTPUT	Alarm Parameters Section 12.3
A1.TYP	ALARM 1 TYPE	Alarm Parameters Section 12.3
ADDR	COMMUNICATIONS ADDRESS	Digital Comms Section 15.2
A-M	LOOP MODE - AUTO MANUAL OFF	Control List Section 11.10
ATUNE	INTEGRAL TIME	Control List Section 11.10
AT.R2G	AUTO-TUNE CONFIGURES R2G	Control List Section 11.10
BAUD	COMMUNICATIONS BAUD RATE	Digital Comms Section 15.2
C.ADJ	CALIBRATION ADJUST	Calibration Section 16.4
CBHI	CUTBACK LOW	Control List Section 11.10
CBLO	CUTBACK HIGH	Control List Section 11.10
CJ.TYP	CJC TYPE	Input List Section 8.1
CJC.IN	CJC TEMPERATURE	Input List Section 8.1
COLD	COLD START ENABLE/ DISABLE	Access List Section 6.4
CONF.P	CONFIG PASSCODE	Access List Section 6.4
COOL.T	NON LINEAR COOLING TYPE	Control List Section 11.10
CT.ID	MODULE TYPE	CT List Section 9.2
CT.LAT	CT ALARM LATCH TYPE	CT List Section 9.2
CT.MTR	CT METER RANGE	CT List Section 9.2
CT.RNG	CT RANGE	CT List Section 9.2
CT.SRC	CT SOURCE	CT List Section 9.2
CTRL.A	CONTROL ACTION	Control List Section 11.10
CTRL.C	COOLING TYPE	Control List Section 11.10
CTRL.H	HEATING TYPE	Control List Section 11.10
CYCLE	PROGRAM CYCLE	Timer Parameters Section 13.1
D.BAND	CHANNEL 2 DEAD BAND	Control List Section 11.10
dC.OP	0-20mA output non-isolated	Output List I/O1 Section 9.1.1. Output List OP2 Section 9.1.7. Output List OP3 Section 9.1.8.
dC.rt	0-20mA output isolated	Output List OP2 Section 9.1.7.
DEC.P	DISPLAY POINTS	Input List Section 8.1
DELAY	RX/TX DELAY TIME	Digital Comms Section 15.2
DWELL.1	DWELL 1	Timer Parameters Section 13.1
DWELL	SET TIMER DURATION	Timer Parameters Section 13.1
ENT.T	TIMER END TYPE	Timer Parameters Section 13.1
EVENT	EVENT OUTPUTS	Timer Parameters Section 13.1
F.MOD	FORCED MANUAL OUTPUT MODE	Control List Section 11.10
F.OP	FORCED OUTPUT	Control List Section 11.10
FILT.T	FILTER TIME	Input List Section 8.1

Mnemonic	Parameter Description	Location
GO	START CALIBRATION	Calibration Section 16.4
GOTO	SELECT ACCESS LEVEL	Access List Section 6.4
HC.ALM	OVER CURRENT THRESHOLD	CT List Section 9.2
HOME	HOME DISPLAY See Note 1	Access List Section 6.4
HYST.C	COOLING HYSTERESIS	Control List Section 11.10
HYST.H	HEATING HYSTERESIS	Control List Section 11.10
ID	CUSTOMER ID	Access List Section 6.4
ID	MODULE IDENTITY	Digital Comms Section 15.2
IM	INSTRUMENT MODE	Modbus Address Section 15.6
IN.TYP	INPUT TYPE	Input List Section 8.1
K.LOC	KEYBOARD LOCK	Access List Section 6.4
L.D.IN	LOGIC INPUT FUNCTION	Logic Input List Section 9.1.10
L.SENS	LOGIC INPUT SENSE	Logic Input List Section 9.1.10
L.TYPE	LOGIC INPUT TYPE	Logic Input List Section 9.1.10
LBR	LOOP BREAK STATUS	Control List Section 11.10
LBT	LOOP BREAK TIME	Control List Section 11.10
LD.ALM	LOAD CURRENT THRESHOLD	CT List Section 9.2
LD.AMP	LOAD CURRENT	CT List Section 9.2
LEV2.P	LEVEL 2 PASSCODE	Access List Section 6.4
LEV3.P	LEVEL 3 PASSCODE	Access List Section 6.4
LK.ALM	LEAK CURRENT THRESHOLD	CT List Section 9.2
LK.AMP	LEAK CURRENT	CT List Section 9.2
LOC.T	LOCAL SETPOINT TRIM	Setpoint List Section 10.1
L-R	REMOTE SETPOINT SELECT	Setpoint List Section 10.1
METER	METER CONFIGURATION	Access List Section 6.4
MR	MANUAL RESET	Control List Section 11.10
MTR.T	MOTOR TRAVEL TIME	Control List Section 11.10
MV.HI	LINEAR INPUT HIGH	Input List Section 8.1
MV.IN	MILLIVOLT INPUT VALUE	Input List Section 8.1
MV.LO	LINEAR INPUT LOW	Input List Section 8.1
OP.HI	OUTPUT HIGH	Control List Section 11.10
OP.LO	OUTPUT LOW	Control List Section 11.10
P.CYCL	PROGRAM CYCLES	Timer Parameters Section 13.1
PASS.2	FEATURE PASSCODE	Access List Section 6.4
PASS.C	FEATURE PASSCODE	Access List Section 6.4
PB	DERIVATIVE TIME	Control List Section 11.10
PB.UNT	Proportional band units	Control List Section 11.10
PHASE	CAL PHASE	Calibration Section 16.4
PRTY	COMMUNICATIONS PARITY	Digital Comms Section 15.2
PV.IN	PV INPUT VALUE	Input List Section 8.1
PV.OFS	PV OFFSET	Input List Section 8.1
R2G	INTEGRAL TIME	Control List Section 11.10

Mnemonic	Parameter Description	Location
RAMP.U	SETPOINT RAMP UNITS	Setpoint List Section 10.1
R.C.F.T	Filter time constant for the rate of change alarm.	Modbus addresses section 15.6
R.C.P.V	Calculated rate of change of PV in engineering units per minute.	Modbus addresses section 15.6
REG.AD	COMMS RETRANSMISSION ADDRESS	Digital Comms Section 15.2
REM.HI	REMOTE INPUT HIGH SCALAR	Setpoint List Section 10.1
REM.LO	REMOTE INPUT LOW SCALAR	Setpoint List Section 10.1
REM.SP	REMOTE SETPOINT	Setpoint List Section 10.1
RETRAN	COMMS RETRANSMISSION	Digital Comms Section 15.2
RMP.1	RAMP RATE 1	Timer Parameters Section 13.1
RNG.HI	RANGE HIGH LIMIT	Input List Section 8.1
RNG.LO	RANGE LOW LIMIT	Input List Section 8.1
ROP.HI	SETPOINT RETRANS HIGH	Setpoint parameters section 10.1
ROP.LO	SETPOINT RETRANS LOW	Setpoint parameters section 10.1
SAFE	SAFE OUTPUT POWER	Control List Section 11.10
SB.TYP	SENSOR BREAK TYPE	Input List Section 8.1
SERV.O	SERVO MODE	Timer Parameters Section 13.1
SP.HI	SETPOINT HIGH LIMIT	Setpoint List Section 10.1
SP.LO	SETPOINT LOW LIMIT	Setpoint List Section 10.1
SP.RAT	SETPOINT RATE LIMIT	Setpoint List Section 10.1
SP.SEL	SETPOINT SELECT	Setpoint List Section 10.1
SP.1	SETPOINT 1	Setpoint List Section 10.1
SP.2	SETPOINT 2	Setpoint List Section 10.1
SS.PWR	SOFT START POWER LIMIT	Timer Parameters Section 13.1
SS.SP	SOFT START SETPOINT	Timer Parameters Section 13.1
STBY.T	STANDBY TYPE	Access List Section 6.4
T.ELAP	ELAPSED TIME	Timer Parameters Section 13.1
T.REMN	TIME REMAINING	Timer Parameters Section 13.1
T.STAT	TIMER STATUS	Timer Parameters Section 13.1
TD	DERIVATIVE TIME	Control List Section 11.10
THRES	TIMER START THRESHOLD	Timer Parameters Section 13.1
TI	RELATIVE COOL GAIN	Control List Section 11.10
TM.CFG	TIMER CONFIGURATION	Timer Parameters Section 13.1
TM.RES	TIMER RESOLUTION	Timer Parameters Section 13.1
TSP.1	TARGET SETPOINT 1	Timer Parameters Section 13.1
TU.HI	TUNE HIGH LIMIT	Control section 11.2
TU.LO	TUNE LOW LIMIT	Control section 11.2
UCAL	USER CALIBRATION	Calibration Section 16.4
UNITS	DISPLAY UNITS	Input List Section 8.1

L		Proportional Band	58, 61, 63, 70, 88
L.OP	47	PROPORTIONAL BAND	25, 56, 87
L.tc	40	Proportional Band Units	70
Latched Alarms	74	PROPORTIONAL BAND UNITS	56
Latching Alarm	73	PV DERIVATIVE	40
LEAK	26, 51	PV INPUT VALUE	39
LEAK CURRENT	26, 51	PV OFFSET	39
LEAK CURRENT THRESHOLD	26, 51		
LEV 1	33		
LEV 2	33	Q	
Lev.1	36	Quick Start Code	6, 13, 14, 19, 21
Lev.2	36		
Lev.3	36	R	
LEVEL 2 PASSCODE	36	r.tc	40
LEVEL 3 PASSCODE	36	ramp	28, 29, 30, 31, 53, 79, 80, 81, 82, 83, 84
Linear	12, 19, 39, 42, 105	RAMP RATE 1	25, 80
LINEAR INPUT HIGH	39	RANGE HIGH LIMIT	39
LINEAR INPUT LOW	39	RANGE LOW LIMIT	39
LOAD	23, 26, 51, 96	RC.FT	134
LOAD CURRENT	23, 26, 51	RC.PV	40, 134
LOAD CURRENT THRESHOLD	26, 51	REC.NO	26, 88
Loc.b	44, 50	RECIP	87, 88
LOCAL SETPOINT TRIM	52	Recipe	87, 88, 126, 127, 128
Logic	9, 10, 11, 13, 44, 47, 50	Relative Cool Gain	54, 59, 61, 63, 67
LOGIC INPUT FUNCTION	50	Relay	9, 10, 11, 13, 14, 44, 46, 47, 48, 49, 74, 132
LOGIC INPUT TYPE	50	ReLy	44
LOOP BREAK STATUS	57	REM.HI	24, 52
LOOP BREAK TIME	56	REM.LO	24
LOOP MODE - AUTO MANUAL OFF	57	REMOTE INPUT HIGH SCALAR	52
Low Cutback	59, 60, 67	REMOTE INPUT LOW SCALAR	52
		REMOTE SETPOINT	52
		REMOTE SETPOINT SELECT	52
M		Reset	24, 27, 30, 60, 79, 84, 106
Manual	21, 22, 44, 47, 48, 54, 55, 60, 67, 73, 77	RNG.HI	39, 66
MANUAL RESET	25, 56	RNG.LO	39, 42, 66
Meter Configuration	37	ROC FILTER TIME	40
MILLIVOLT INPUT VALUE	40	ROP.HI	96
Modbus	15, 89, 90, 91, 92, 93, 131	ROP.LO	96
MODULE IDENTITY	90	rrc	23, 25, 76
MODULE TYPE	51	Rtd40	
MOTOR TRAVEL TIME	25, 57	RTD	12, 19, 39, 42, 99, 104, 105, 109, 131
Mounting	1, 7	Run	19, 20, 24, 27, 30, 82, 84, 85, 88
mV	12, 39, 40, 42, 104, 105, 106, 107	RX/TX DELAY TIME	90
		S	
N		S.tc	40
n.tc	40	SAFE	21, 41, 57, 72
Non latching	21, 73	SAFE OUTPUT POWER	57
None	20, 24, 51, 76, 90, 132	Sbr	39, 44, 47, 48, 49
NON-LINEAR COOLING TYPE	57	Sby	44, 50
nw.AL	44, 47, 48, 49	SELECT ACCESS LEVEL	36
		SENSE	45, 47, 48, 49, 50
O		SENSOR BREAK TYPE	39
OFS.HI	98	SERVO MODE	25, 30, 79
OFS.LO	98	SET TIMER DURATION	80
On/Off Control	54, 97	SETPOINT 1	23, 24, 25, 52, 80
One-shot	63	SETPOINT 2	23, 24, 52
OP.HI	26, 41, 57, 69, 70	SETPOINT HIGH LIMIT	52
OP.LO	26, 41, 57, 69, 70	SETPOINT LOW LIMIT	52
OP-2	43, 47, 51, 62, 82, 84	Setpoint Parameters	52
OP-3	43, 48, 62, 82	SETPOINT RAMP UNITS	52
Order code	13	SETPOINT RATE LIMIT	24, 52
OUTPUT 1 MINIMUM PULSE TIME	45	SETPOINT RETRANS HIGH	52
OUTPUT 2 TYPE	47	SETPOINT RETRANS LOW	52
OUTPUT 3 TYPE	48	SETPOINT SELECT	52
OUTPUT HIGH	26, 57	Sleeve	6, 7
OUTPUT MINIMUM PULSE TIME	47, 48, 49, 133	SOFT START POWER LIMIT	24, 79
Output Power	100	SOFT START SETPOINT	79
Over/Under range	39	SP	13, 23, 52, 54, 92
		SS.PWR	24, 29, 79
P		SS.SP	24, 25, 29, 79
Parity	100	STORE	26, 87
PID	54, 56	Switch On	19
PNT.HI	98		
PNT.LO	98	T	
Power Supply	14, 16	t.tc	40
PROGRAM CYCLE	80	TARGET SETPOINT 1	25, 80
PROGRAM CYCLES	80	TC	39
Programmer	6, 24, 29, 30, 31, 79, 80, 81, 82, 83, 84	TD	25, 54, 56, 59, 67
		terminals	9, 12, 13, 50, 89

Thermocouple	12, 19, 40, 104, 108		
TI	25, 54, 56, 57, 58, 61, 67		
TIME REMAINING	23, 25, 80		
Timer	27, 28, 29, 79, 84, 132		
TIMER CONFIGURATION	24, 79	U.CAL	106
TIMER END TYPE	24, 79	UNITS	24, 39, 52, 56
TIMER RESOLUTION	24, 79	User calibration	39, 131
TIMER START THRESHOLD	24, 79	USER CALIBRATION	113
TIMER STATUS	24, 79		
Tuning	61, 63, 66, 67		
Type 1	131		
		W	
		Wiring	9, 16, 17, 89, 91
		WKG.SP	23, 24
		www.eurotherm.co.uk	89, 114

